

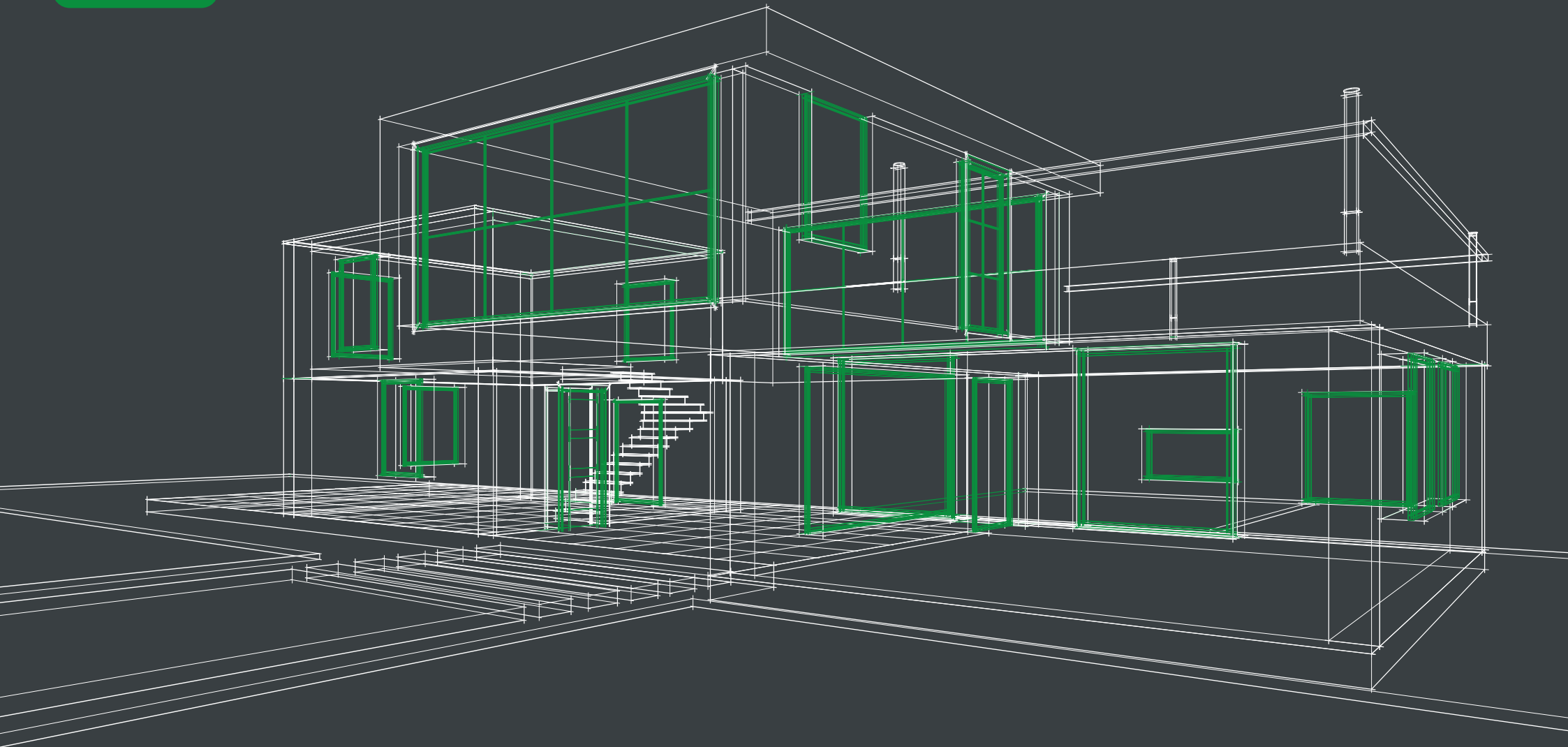

# NOUVEAU POINT DE VUE



Catalogue technique

## Couleurs disponibles

- couleurs standards  
 couleurs non standards

Référence	Désignation
001	Blanc
101505	Ivoire
1087.05	Jaune
1293001	Platine crown
1293002	Platine de quartz
1293010	Platine earl
1379.05	Blanc crème
2052.089	Chêne foncé
2065021	Acajou
2115008	Oregon III
2178001	Chêne doré
2178007	Noyer
300305	Rouge rubis
300505	Rouge bordeaux
305405	Rouge carmin
3069037	Douglas
3069.041	Sapin
3081.05	Rouge brun
3118076	Chêne clair
3152009	Douglas strié
3156.003	Chêne rustique
3162002	Macoré
3202002	Palissandre
436.1001	Aluminium brossé

Référence	Désignation
4361002	Aluminium brossé argenté
4361014	Alux DB 703
4367003	Gris anthracite lisse
4467062	Jet black
4563081	Chêne Sheffield clair
49195	Shogun AD
49197	Shogun AC
49198	Shogun AF
49233	Siena Rosso
49237	Siena PN Noce
49240	Winchester XA
500205	Bleu outremer
500405	Bleu monumental
5007.05	Bleu brillant
5013.05	Bleu cobalt
5150.05	Bleu acier
6004.05	Bleu-vert
6005.05	Vert
6110.05	Vert émeraude
6125.05	Vert sapin structuré
7012.05	Gris basalte
701205083	Gris basalte lisse
701505	Gris ardoise
701505083	Gris ardoise lisse

Référence	Désignation
7016.05	Gris anthracite structuré
701605001	Anthracite Ultramat VSP - Spectral
7038.05	Gris agathe
703905	Gris quartz
704000001	Gris platine Ultramat VSP - Spectral
715505	Gris argenté
7155.05-083	Gris argenté lisse
7251.05	Gris clair
800400001	Terre d'ombre Ultramat VSP - Spectral
851805	Brun noir
8875.05	Brun
901805	Blanc papyrus
915205	Blanc renolit
992505	Vert monumental
992505001	Vert monumental Ultramat VSP - Spectral
300505001	Bordeaux Ultramat VSP - Spectral
515005001	Bleu marine Ultramat VSP - Spectral
600900001	Vert foncé Ultramat VSP - Spectral
701605001	Anthracite Ultramat VSP - Spectral
704000001	Gris platine Ultramat VSP - Spectral
900100001	Crème Ultramat VSP - Spectral
901000001	Blanc crème Ultramat VSP - Spectral
901100001	Noir graphite Ultramat VSP - Spectral
915205001	Blanc Ultramat VSP - Spectral

EFFECTLINE.....	4-5
PERFECTLINE .....	6-13
S-LINE .....	14-17
SWINGLINE.....	18-21
SOFTLINE 82.....	22-23
SOFTLINE 76.....	24-25
ACCESSOIRES .....	26-37
PORTES d'entrée 120 mm/ Porte de service 105mm .....	38-41
COULISSANTS patios, ekosol, hst.....	42-47
QUINCAILLERIE .....	48-51
VOLETS ROULANTS SKT, SKB, SK, SK-P, SKE, SKO, SKO-P, SP, SP-E .....	52-61
VOLETS ROULANTS - pièces détachées - motorisation .....	62-64

ASSEMBLAGE		EFFECTLINE	PERFECTLINE	S-LINE
	ASSEMBLAGE STANDARD DORMANT + OUVRANT	COUPE 101,284/103,304	COUPE 101,208/103,232	COUPE 101,233/103,235
RÉNOVATION	DORMANT RENO 30mm + OUVRANT	X	COUPE 111,208V1/103,232	COUPE 111,208 V1/103,235
	DORMANT RENO 35 mm + OUVRANT	X	COUPE 101,218/103,232	COUPE 101,218 /103,235
	DORMANT RENO 65 mm + OUVRANT	X	COUPE 111,208V0/103,232	COUPE 111,208 V0/103,235
MONOBLOC	DORMANT 101.241 + OUVRANT	X	COUPE 101,241/103,232	X
	DORMANT 101.242 + OUVRANT	X	COUPE 101,242/103,232	X
	DORMANT 101.243 + OUVRANT	X	COUPE 101,243/103,232	X
	DORMANT 101.244 + OUVRANT	X	COUPE 101,244/103,232	X
	DORMANT 101.240 + OUVRANT	X	COUPE 101,240/103,232	X
MENEAU MOBILE	MENEAU 166 mm	ASSEMBLAGE 101,284/103,304 + MENEAU 102,236	ASSEMBLAGE 101,208/103,232 + MENEAU 102,236	ASSEMBLAGE 101,233/103,235 + MENEAU 102,236
	MENEAU 148 mm	X	ASSEMBLAGE 101,208/103,232 + MENEAU 102,219 POIGNEE DECENTREE	ASSEMBLAGE 101,233/103,235 + MENEAU 102,219 POIGNEE DECENTREE
			ASSEMBLAGE 101,208/103,232 + MENEAU 102,219 + + CACHE DE PROTECTION 109,499 POIGNEE CENTREE	ASSEMBLAGE 101,233/103,235 + MENEAU 102,219 + + CACHE DE PROTECTION 109,499 POIGNEE CENTREE
	MENEAU 132 mm	X	ASSEMBLAGE 101,208/ 103,232 + MENEAU 109,654 POIGNEE DECENTREE	X
		X	ASSEMBLAGE 101,208/103,232 + MENEAU 109.654 + CACHE DE PROTECTION 109,499 POIGNEE CENTREE	X
	MENEAU 112 mm	X	ASSEMBLAGE 101,208/103,229 + MENEAU 109,654 + CACHE DE PROTECTION POIGNEE CENTREE	X
	MENEAU 176 mm	X	X	X
MENEAU 156 mm	X	X	X	
MENEAU FIXE		ASSEMBLAGE 101,284/103,304 + MENEAU 102,214	ASSEMBLAGE 101,208/103,232 + MENEAU 102,214	ASSEMBLAGE 101,233/103,235 + MENEAU 102,249
SEUIL PLAT ALU		ASSEMBLAGE 101,284 AVEC SEUIL ALU 10 mm/103,304	ASSEMBLAGE 101,208 AVEC SEUIL ALU 10 mm/103,232	ASSEMBLAGE 101,233 AVEC SEUIL ALU 10 mm/103,235
<b>PORTE D' ENTREE OUVRANT 120 MM</b>				
	ASSEMBLAGE STANDARD DORMANT + OUVRANT	X	101,208/105,232	X
RÉNOVATION	DORMANT RENO 35 mm + OUVRANT	X	101,218/105,232	X
MONOBLOC	DORMANT 101.241 + OUVRANT	X	101,241/105,232	X
<b>PORTE D' ENTREE OUVRANT 105 MM</b>				
	ASSEMBLAGE STANDARD DORMANT + OUVRANT	X	101,208/103,241	X
RÉNOVATION	DORMANT RENO 35 mm + OUVRANT	X	101,218/103,241	X
MONOBLOC	DORMANT 101.241 + OUVRANT	X	101,241/103,241	X
<b>COULISSANT PATIO</b>				
	ASSEMBLAGE STANDARD DORMANT + OUVRANT	X	101,208/103,232	101,233/103,235
RÉNOVATION	DORMANT RENO 35 mm + OUVRANT	X	101,218/103,232	101,218/103,235
<b>COULISSANT EKOSOL</b>				
	(ASSEMBLAGE STANDARD DORMANT + OUVRANT) 70 AD	105,351/105,322		
	(ASSEMBLAGE STANDARD DORMANT + OUVRANT) 90 AD	105,351/105,321		
<b>COULISSANT A LEVAGE HST</b>				
	(ASSEMBLAGE STANDARD DORMANT + OUVRANT) 70 AD	170/50 - 100		
	(ASSEMBLAGE STANDARD DORMANT + OUVRANT) 82 AD	194/52- 104		

ASSEMBLAGE		SWINGLINE	SOFTLINE 82	SOFTLINE 76
	ASSEMBLAGE STANDARD DORMANT + OUVRANT	COUPE 101,233/103,236	COUPE 101,290/103,341	COUPE 101,350/103,381
RÉNOVATION	DORMANT RENO 30mm + OUVRANT	X	X	X
	DORMANT RENO 35 mm + OUVRANT	X	X	X
	DORMANT RENO 65 mm + OUVRANT	X	X	X
MONOBLOC	DORMANT 101.241 + OUVRANT	X	X	X
	DORMANT 101.242 + OUVRANT	X	X	X
	DORMANT 101.243 + OUVRANT	X	X	X
	DORMANT 101.244 + OUVRANT	X	X	X
	DORMANT 101.240 + OUVRANT	X	X	X
MENEAU MOBILE	MENEAU 166 mm	ASSEMBLAGE 101,233/103,236 + MENEAU 102,236 POIGNEE DECENTREE	X	X
	MENEAU 148 mm	ASSEMBLAGE 101,233/103,23 + MENEAU 102,219 POIGNEE DECENTREE	X	X
		ASSEMBLAGE 101,233/103,23 + MENEAU 102,219 + CACHE DE PROTECTION 109,499 POIGNEE CENTREE	X	X
	MENEAU 132 mm	X	X	X
		X	X	X
	MENEAU 112 mm	X	X	X
	MENEAU 176 mm	X	ASSEMBLAGE 101,290/103,341 + MENEAU 102,316	ASSEMBLAGE 101,350/103,381 + MENEAU 102,356
MENEAU 156 mm	X	ASSEMBLAGE 101,290/103,341+ MENEAU 102,314	ASSEMBLAGE 101,350/103,381 + MENEAU 102,354	
MENEAU FIXE		ASSEMBLAGE 101,233/103,236 + MENEAU 102,249	ASSEMBLAGE 101,290/103,341 + MENEAU 102,310	ASSEMBLAGE 101,290/103,341 + MENEAU 102,310
SEUIL PLAT ALU		ASSEMBLAGE 101,233 AVEC SEUIL ALU 10 mm/103,236	ASSEMBLAGE 101,290 AVEC SEUIL ALU 10 mm/103,341	ASSEMBLAGE 101,350 AVEC SEUIL ALU 10 mm/103,381
<b>PORTE D' ENTREE OUVRANT 120 MM</b>				
	ASSEMBLAGE STANDARD DORMANT + OUVRANT	X	101,290/105,380	101,350/105,400
RÉNOVATION	DORMANT RENO 35 mm + OUVRANT	X	X	X
MONOBLOC	DORMANT 101.241 + OUVRANT	X	X	X
<b>PORTE D' ENTREE OUVRANT 105 MM</b>				
	ASSEMBLAGE STANDARD DORMANT + OUVRANT	X	101,290/103,345	101,350/103,385
RÉNOVATION	DORMANT RENO 35 mm + OUVRANT	X	X	X
MONOBLOC	DORMANT 101.241 + OUVRANT	X	X	X
<b>COULISSANT PATIO</b>				
	ASSEMBLAGE STANDARD DORMANT + OUVRANT	101,233/103,236	101,290/103,341	101,350/103,381
RÉNOVATION	DORMANT RENO 35 mm + OUVRANT	101,218/103,236	X	X
<b>COULISSANT EKOSOL</b>				
	(ASSEMBLAGE STANDARD DORMANT + OUVRANT) 70 AD			
	(ASSEMBLAGE STANDARD DORMANT + OUVRANT) 90 AD			
<b>COULISSANT A LEVAGE HST</b>				
	(ASSEMBLAGE STANDARD DORMANT + OUVRANT) 70 AD			
	(ASSEMBLAGE STANDARD DORMANT + OUVRANT) 82 AD			



dormant + ouvrant

101.284 + 103.304

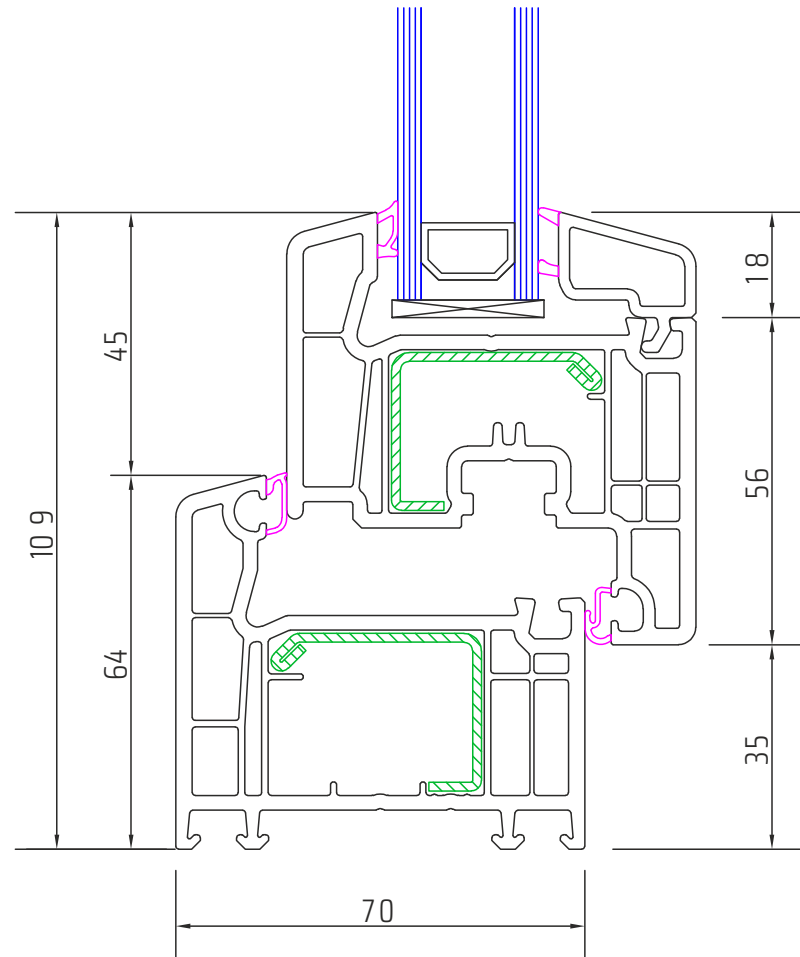

### porte fenêtre seuil plat ALU

104.427 + 103.304

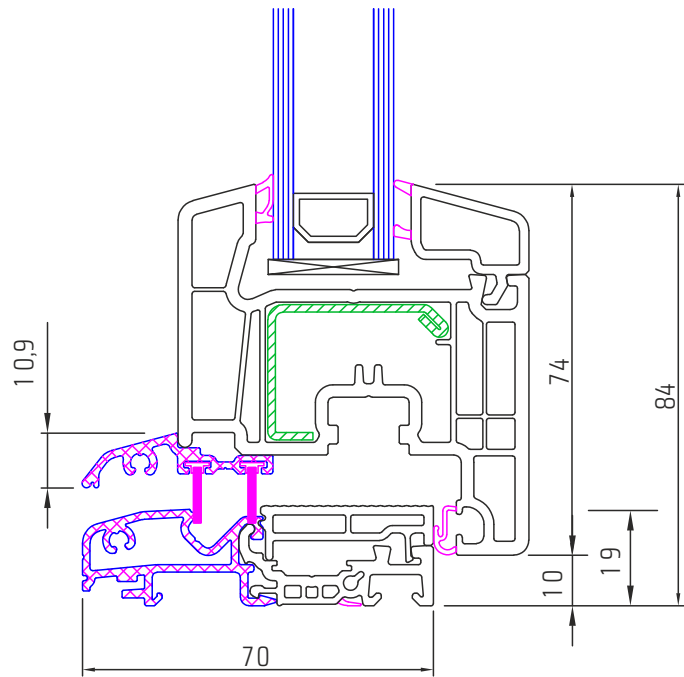

### meneau mobile

103.304 + 102.236 + 103.304

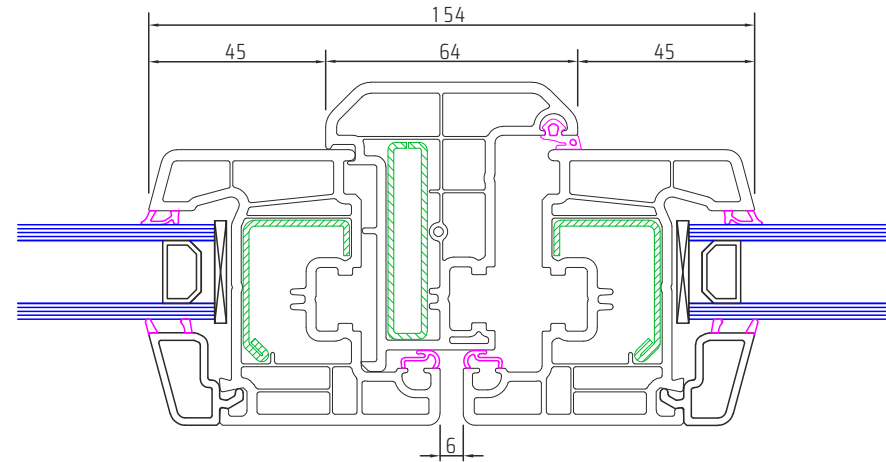

### meneau fixe

103.304 + 102.214 + 103.304

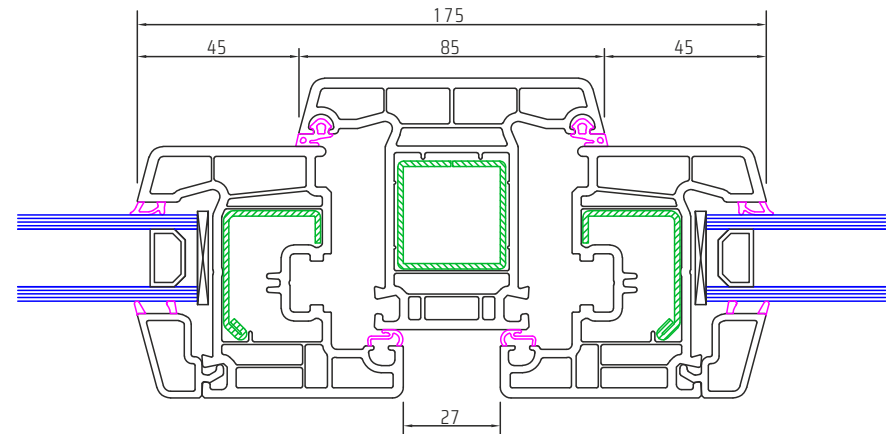



## dormant + ouvrant

101.208 + 103.232

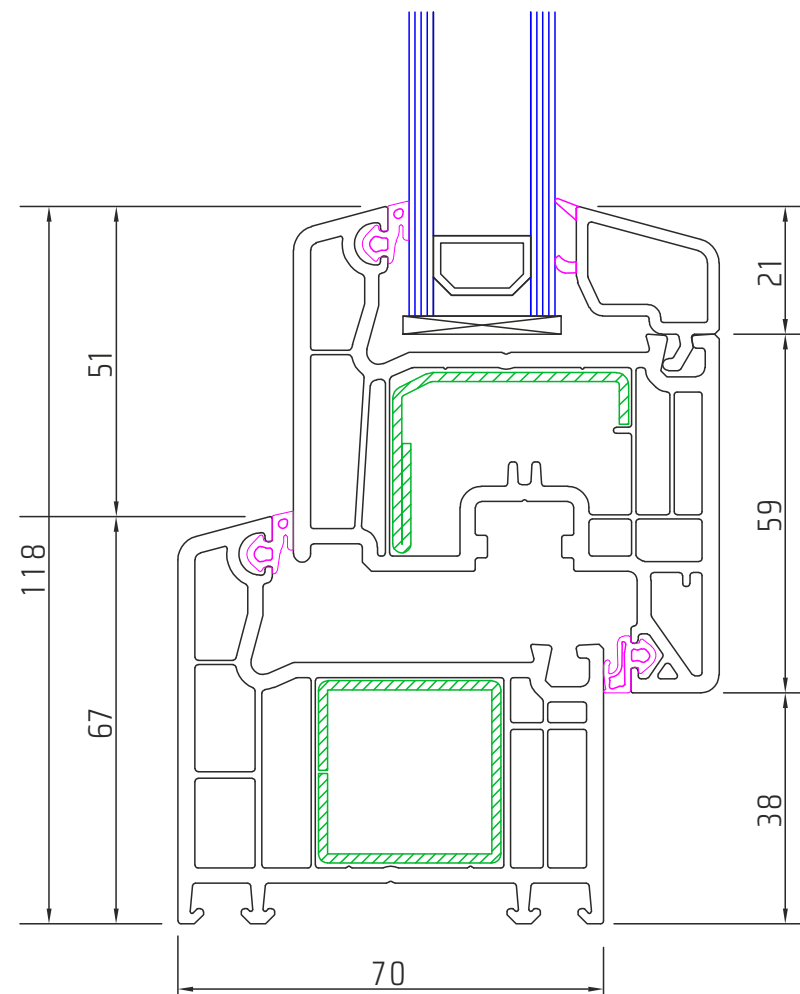



# porte fenêtre seuil plat alu

104.427 + 103.232

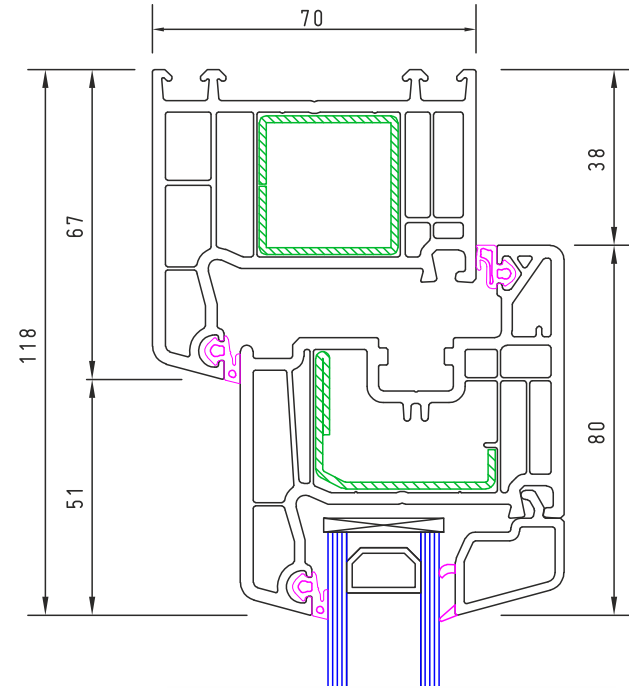
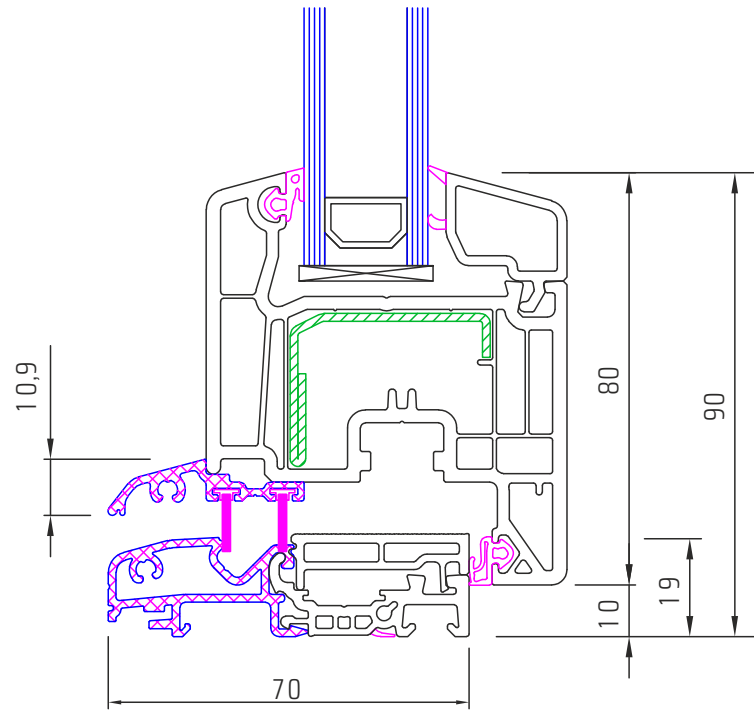

101.208 + 103.232 + 104.427

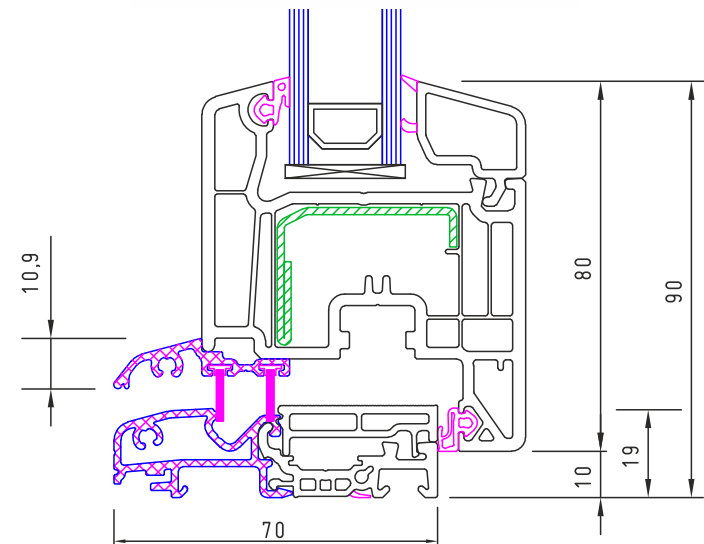

## meneau mobile poignée décentrée

103.229 + 109.654 + 103.229

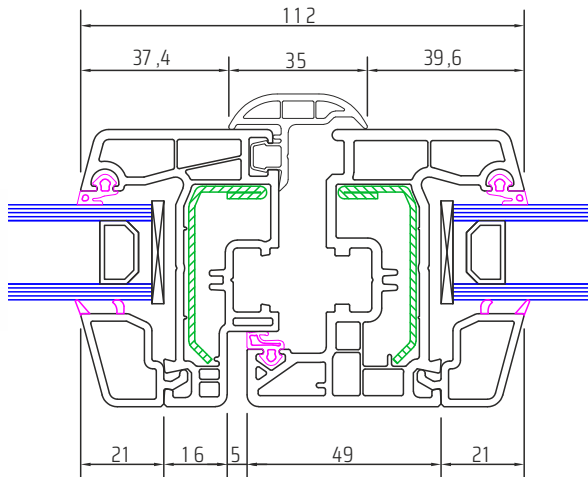

103.229 + 102.219 + 103.229

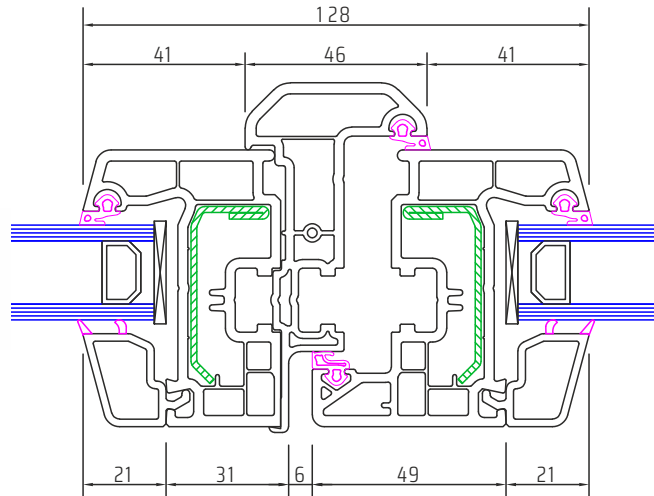

103.232 + 109.654 + 103.232

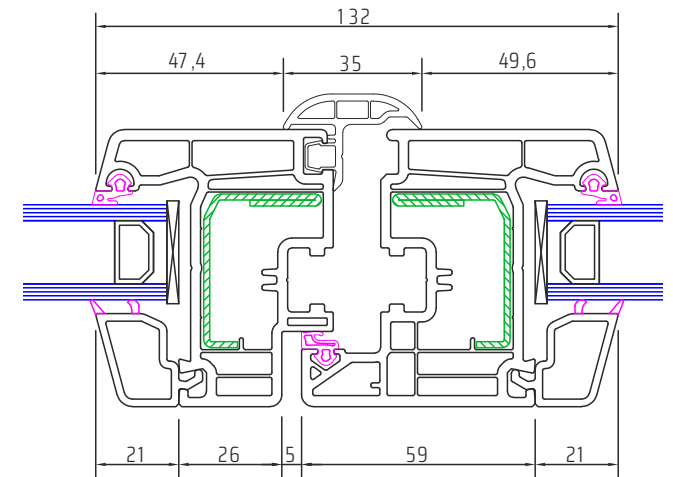

103.232 + 102.219 + 103.232

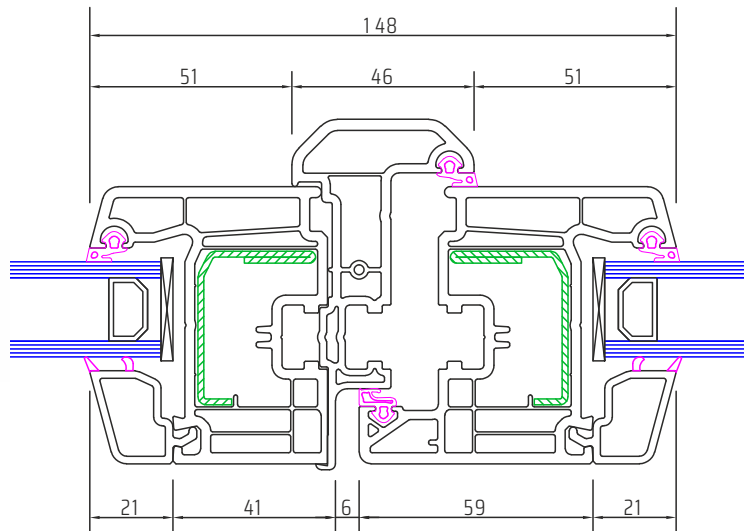

103.232 + 102.236 + 103.232

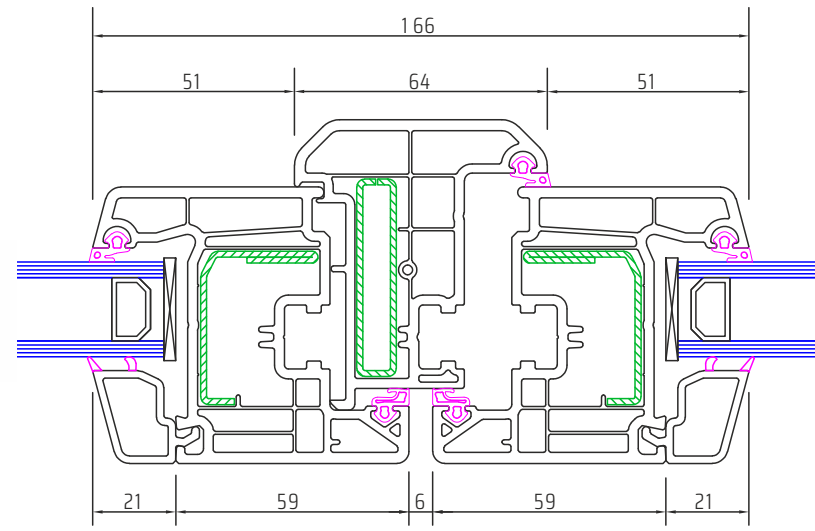

## meneau mobile: poignée centrée avec cache de protection

103.229 + 109.564 + 109.499 + 103.229

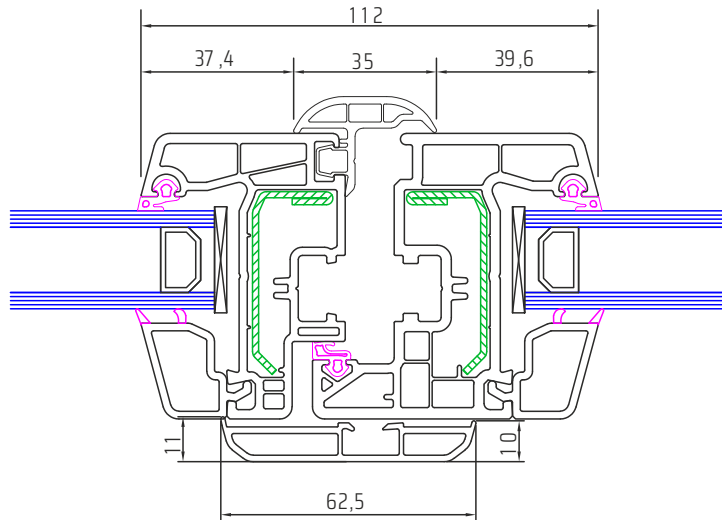

103.229 + 102.219 + 109.499 + 103.229

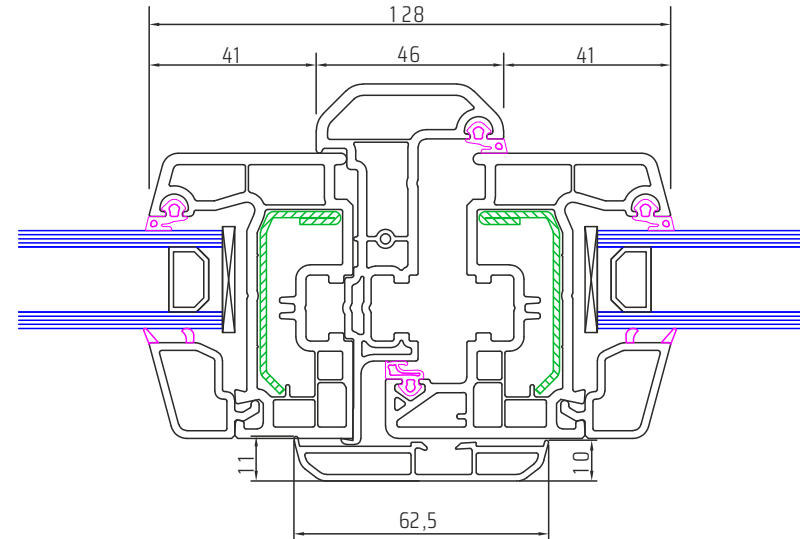

103.232 + 109.654 + 109.499 + 103.232

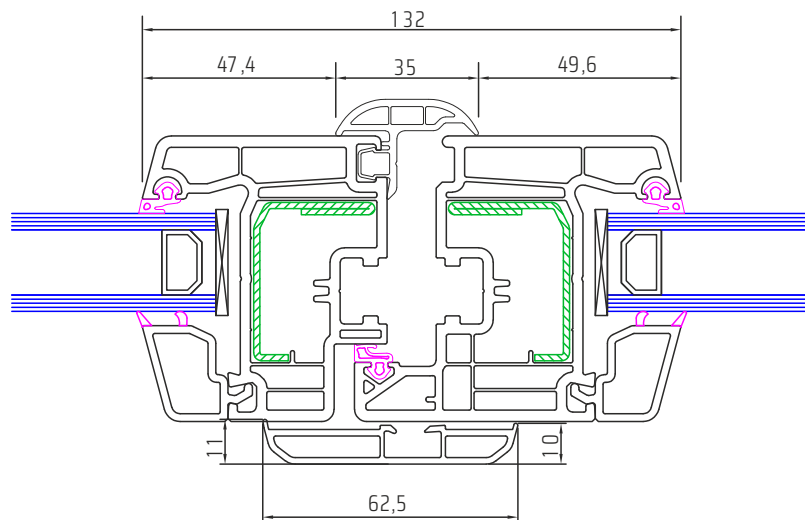

103.232 + 102.219 + 109.499 + 103.232

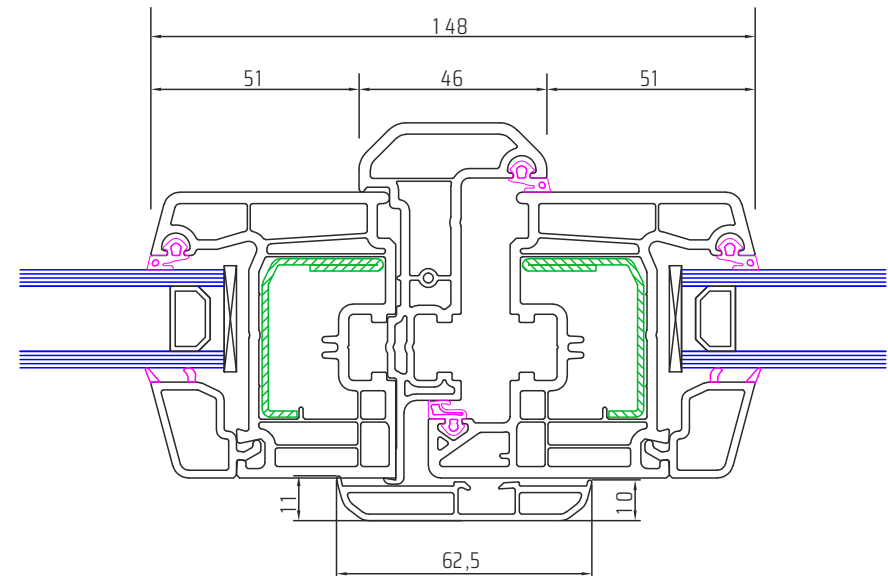

## meneau fixe

103.232+102.214+103.232

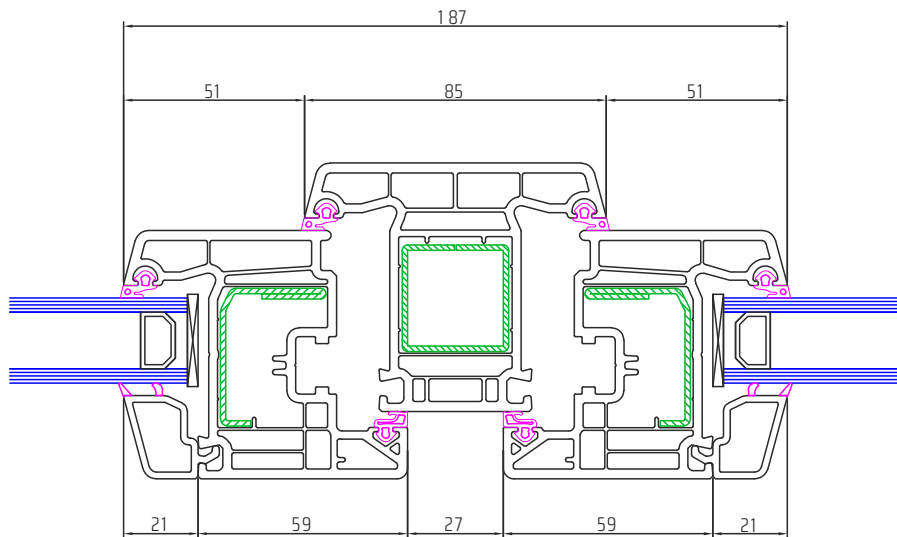

103.232+102.238+103.232

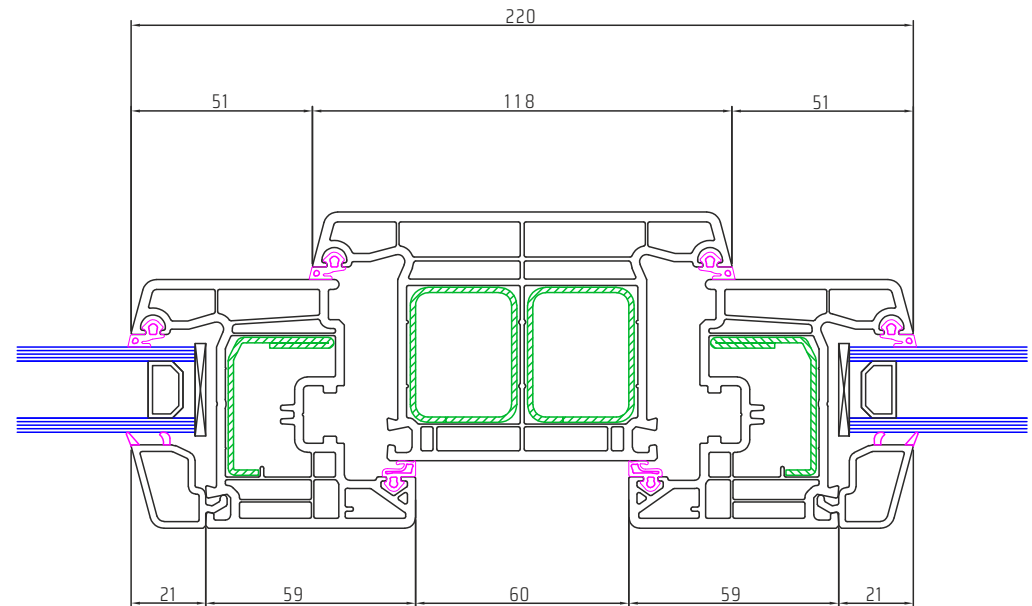

# rénovations

## A30

111.208v1 + 103.232

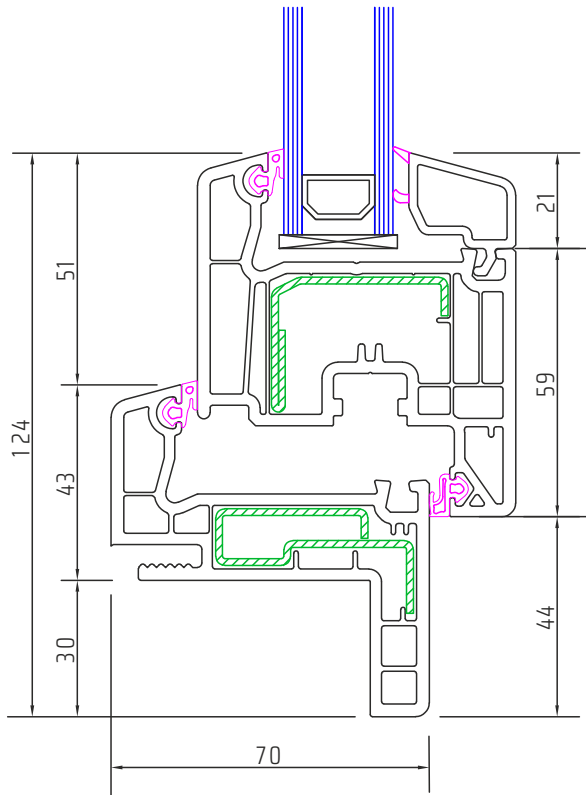

## S35

101.218 + 103.232

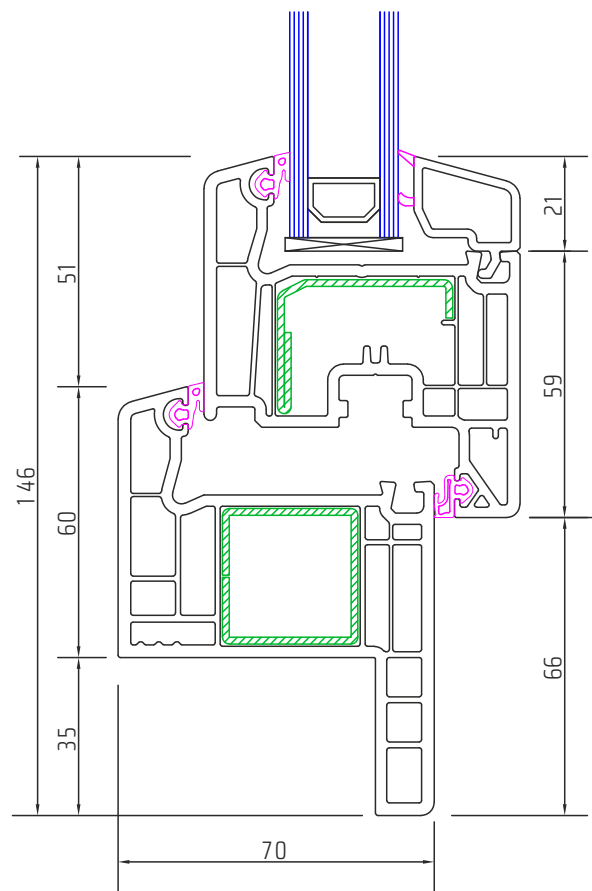

## A65

111.208v0 + 103.232

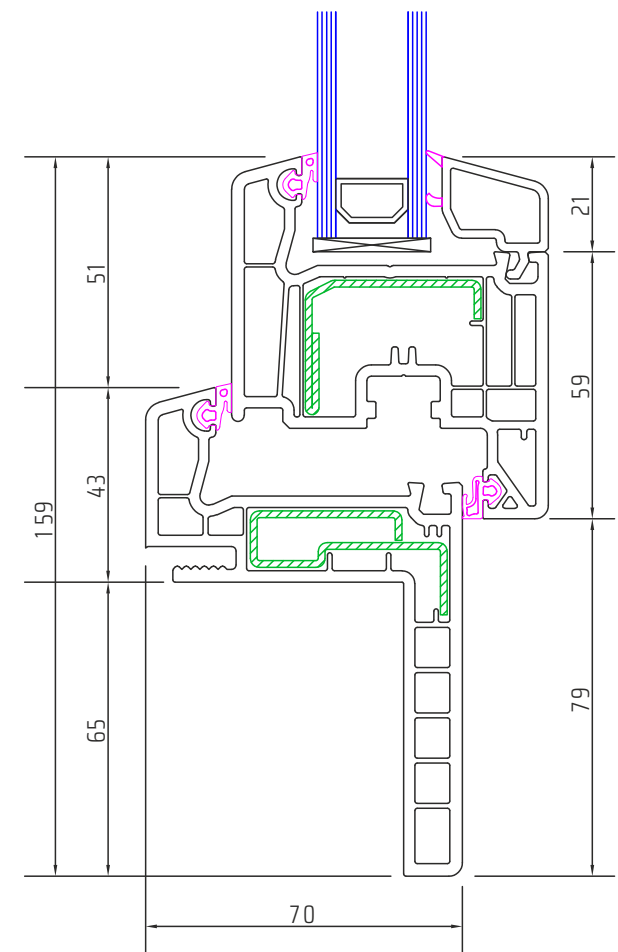

## monobloc

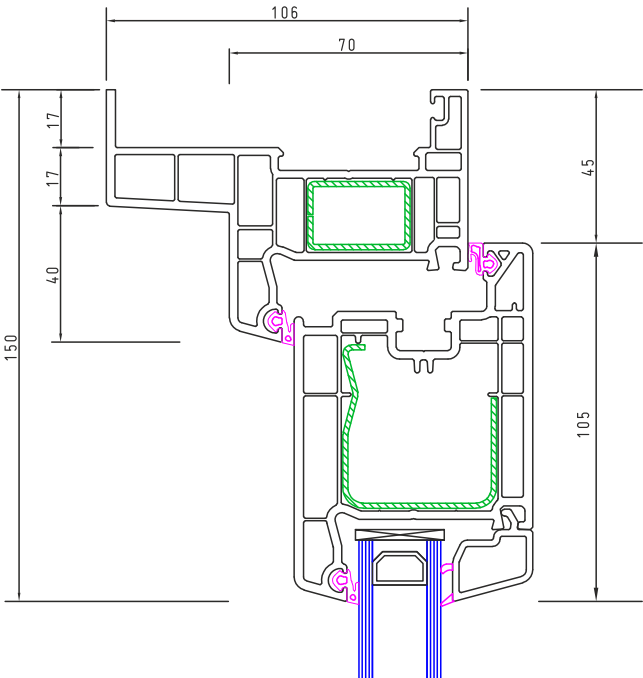

**104.427 + 103.241 + 101.241**

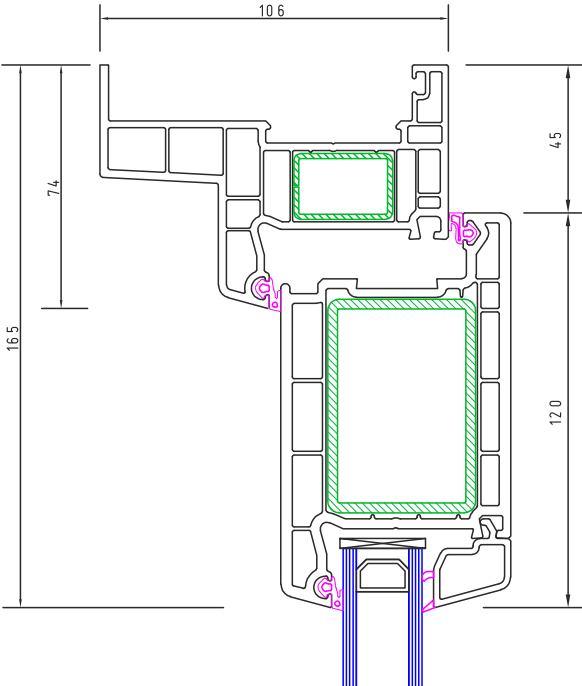

**104.427 + 105.232 + 101.241**

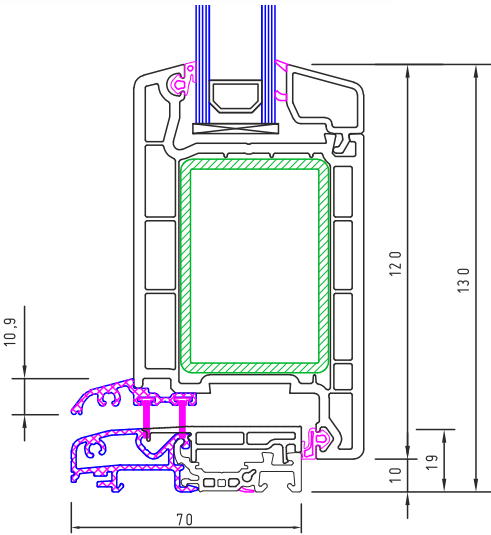
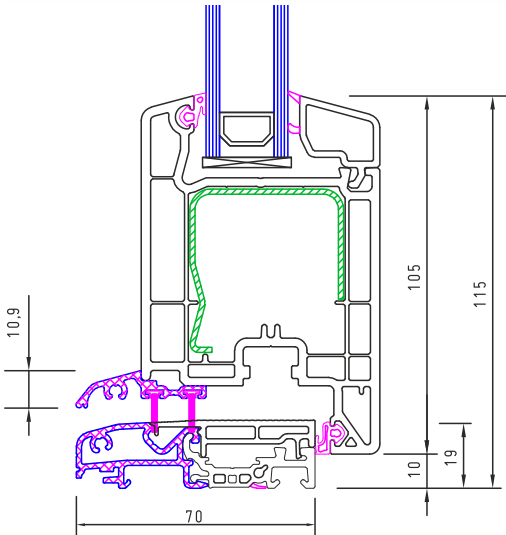

# monobloc

101.240 + 103.232

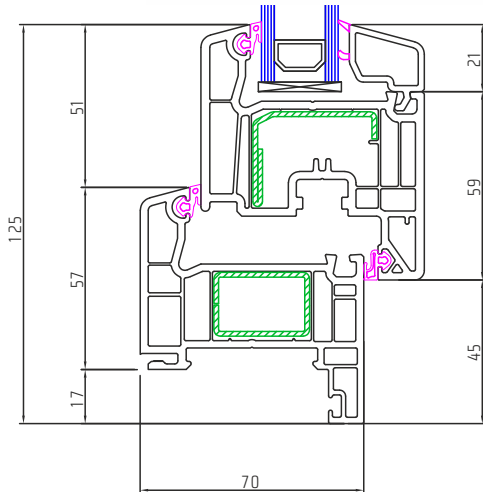

101.241 + 103.232

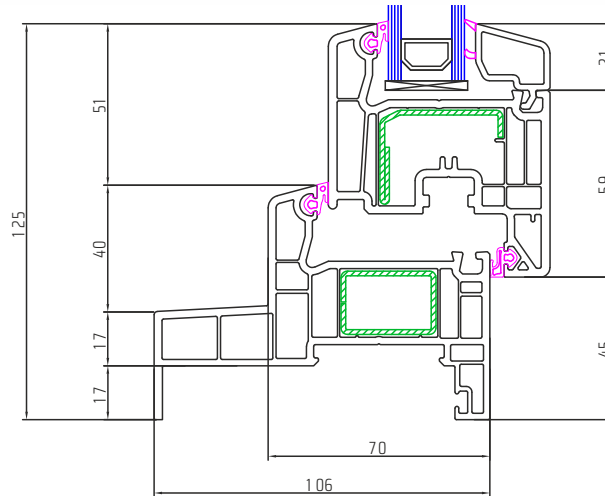

101.242 + 103.232

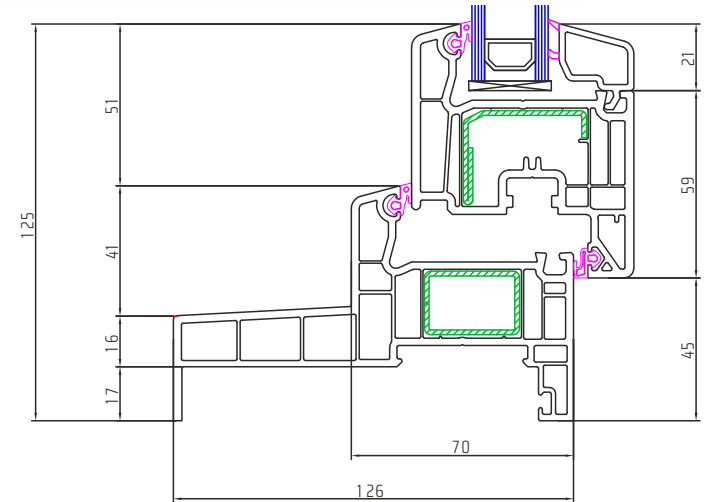

101.243 + 103.232

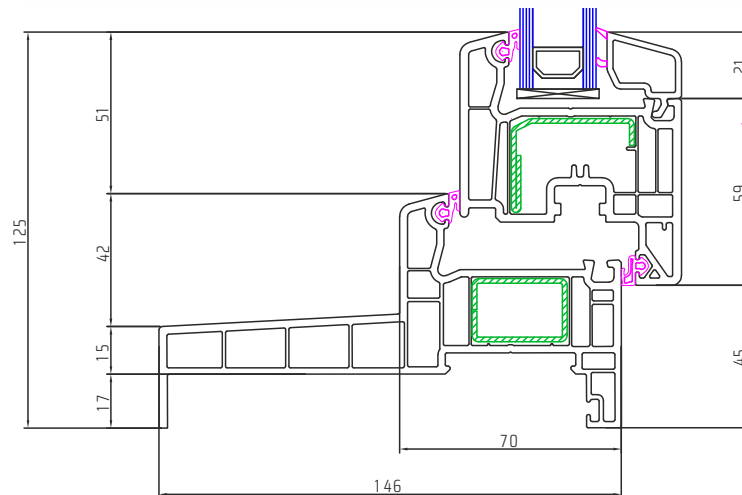

101.244 + 103.232

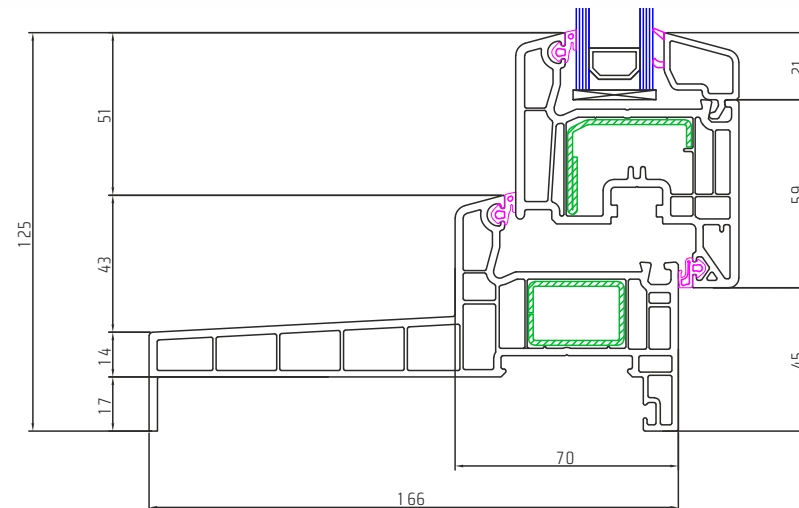



## dormant + ouvrant

101.233 + 103.235

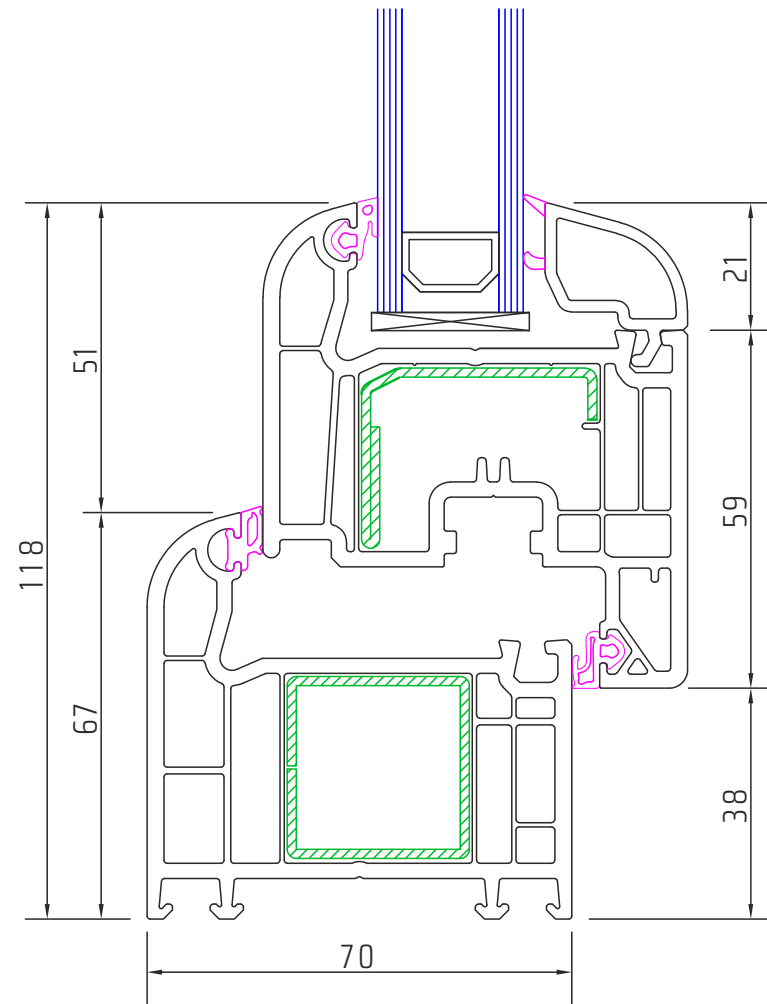



# porte fenêtre seuil plat alu

104.427 + 103.235

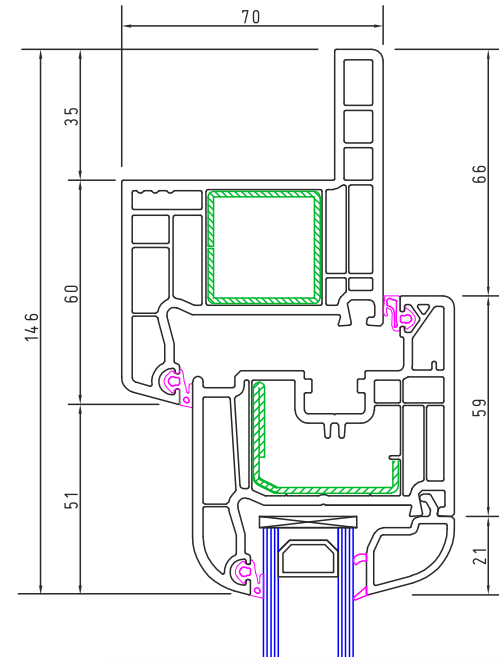
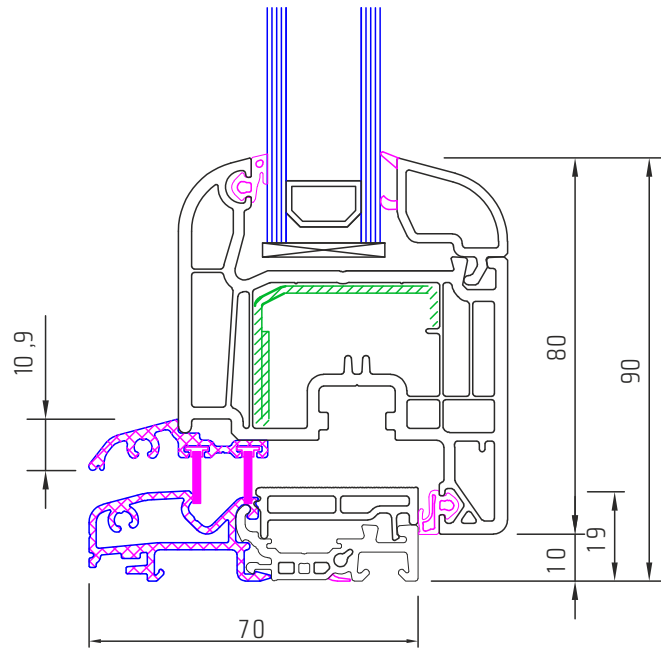

101.218 + 103.235 PATIO reno 35

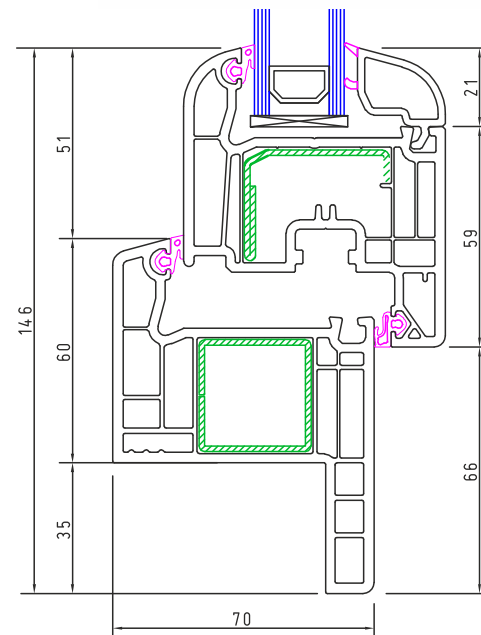

## rénovations

### A30

111.208v1 + 103.235

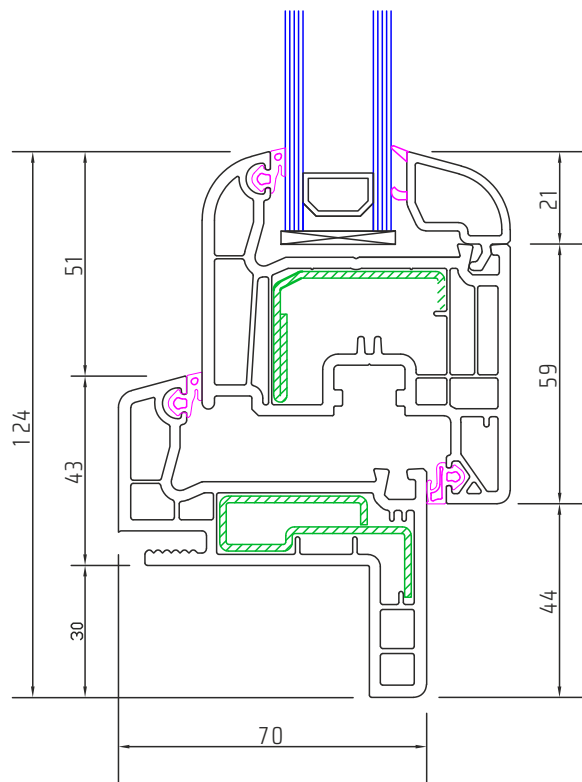

### S35

101.218 + 103.235

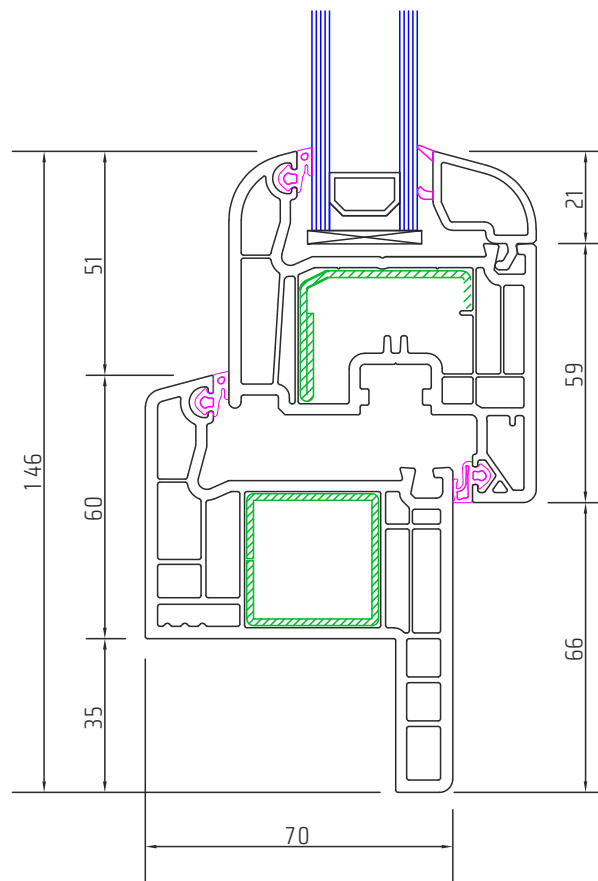

### A65

111.208v0 + 103.235

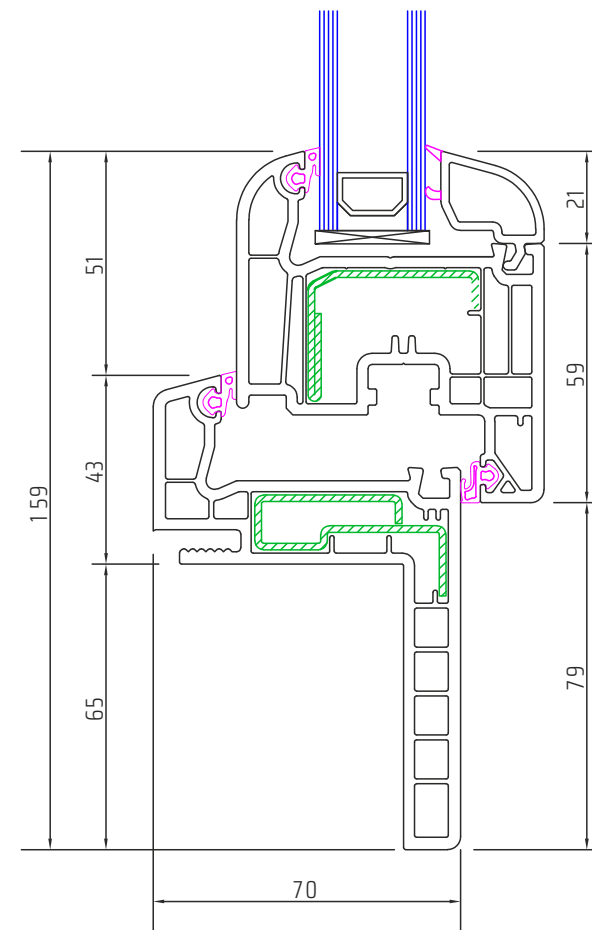

### meneau mobile – poignée décentrée

103.235 + 102.219 + 103.235

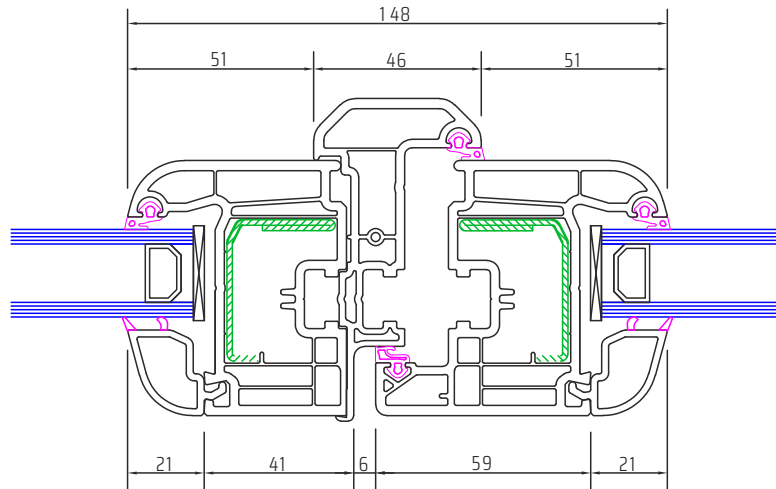

### meneau mobile poignée centrée avec cache de protection

103.235 + 102.219 + 109.499 + 103.235

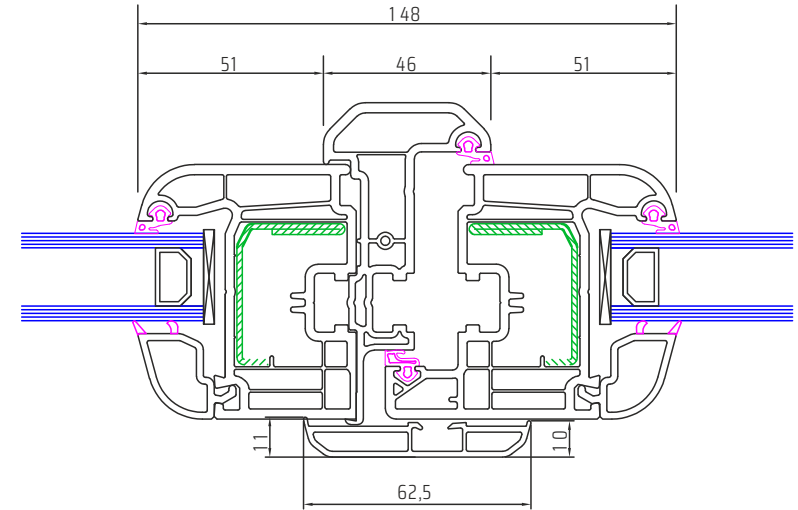

103.235 + 102.236 + 103.235

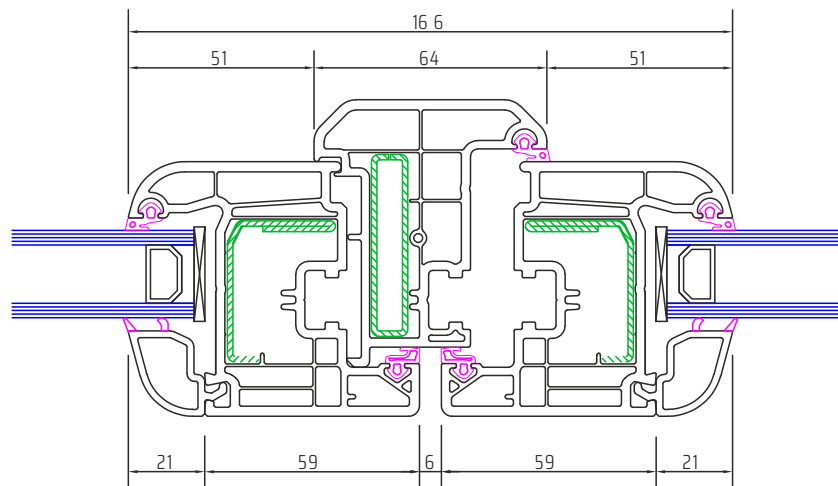

### meneau fixe

103.235 + 102.249 + 103.235

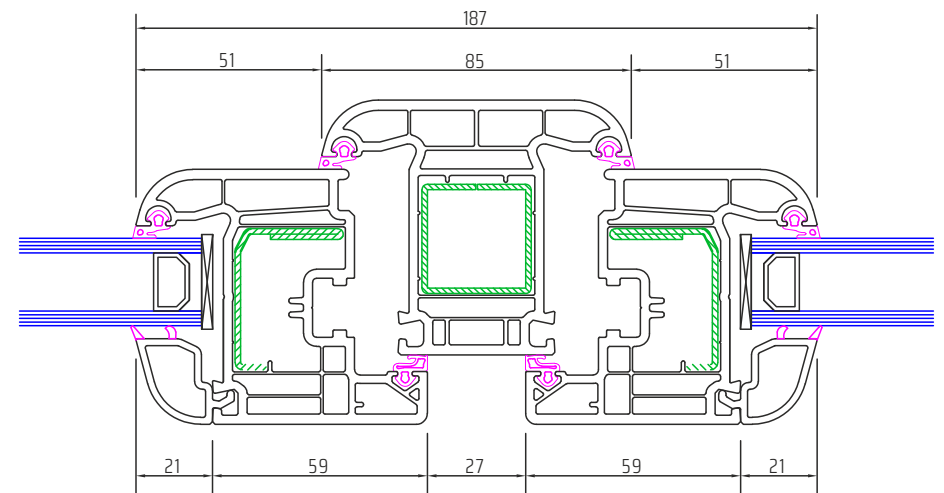



## DORMANT + OUVRANT

101.233 + 103.236

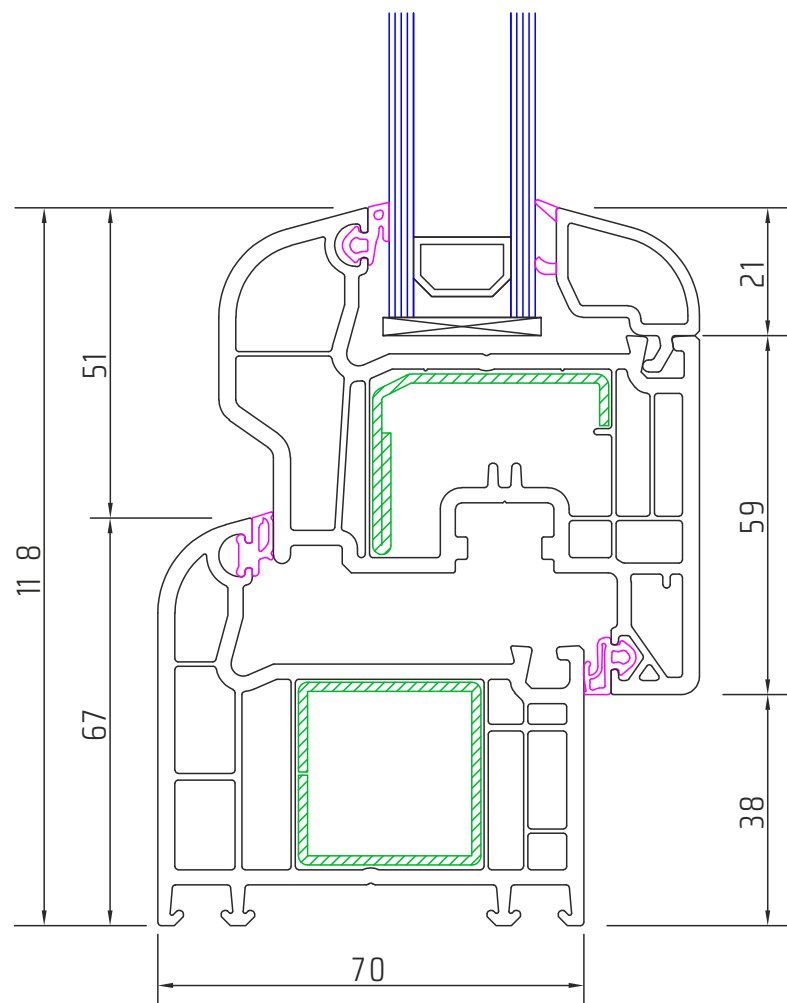

# porte fenêtr seuil plat alu

101.233 + 103.236

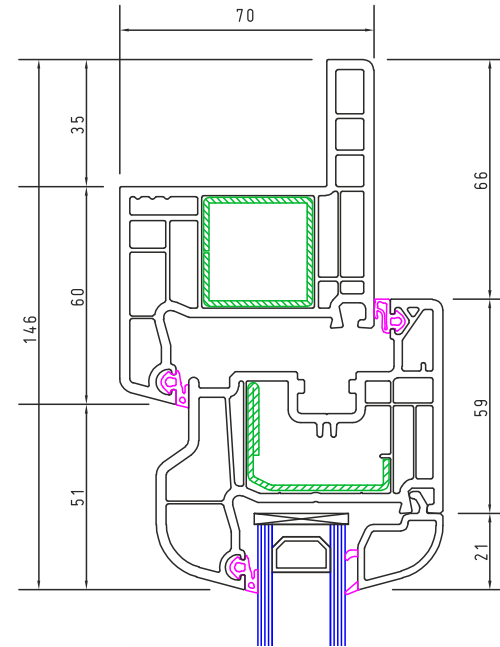
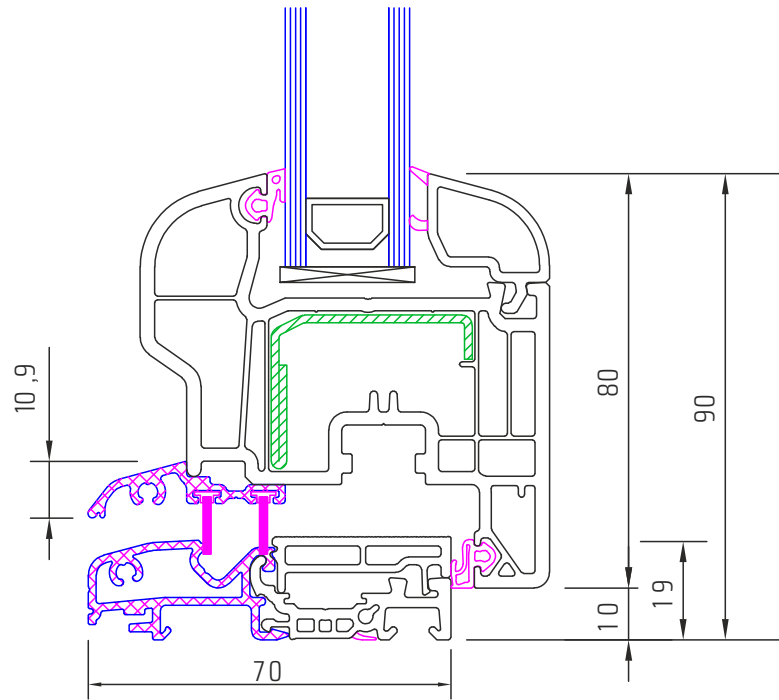

101.218 + 103.236 PATIO reno 35

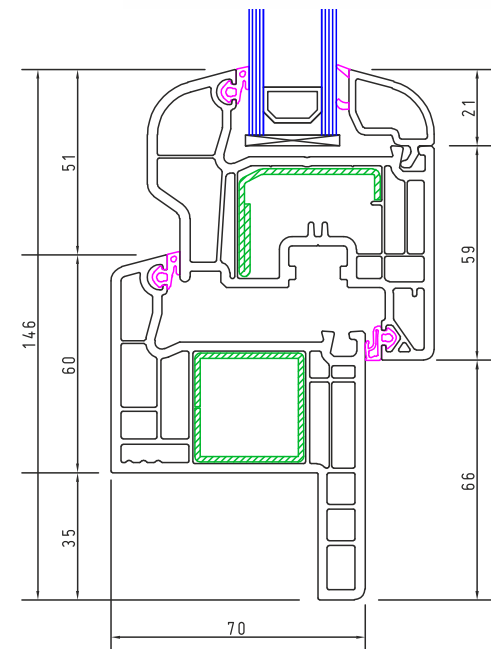

## rénovations

### A30

111.208v1 + 103.236

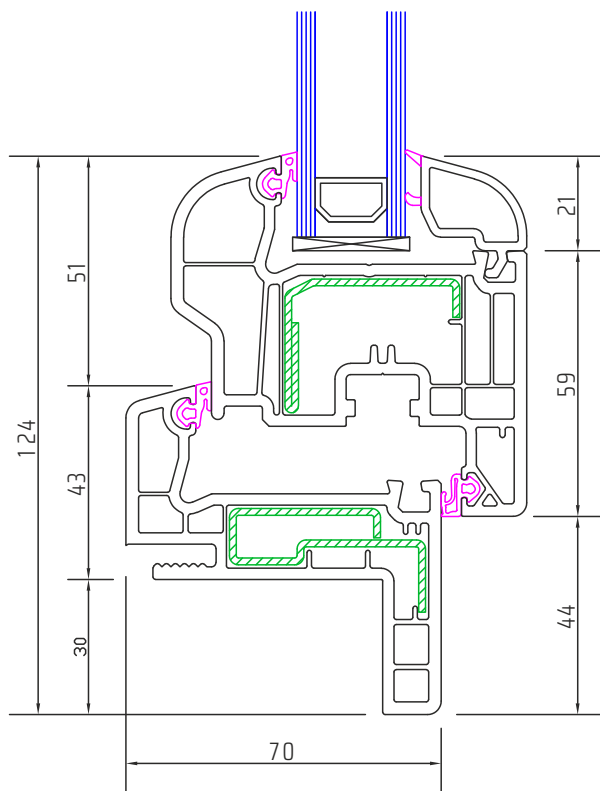

### S35

101.218 + 103.236

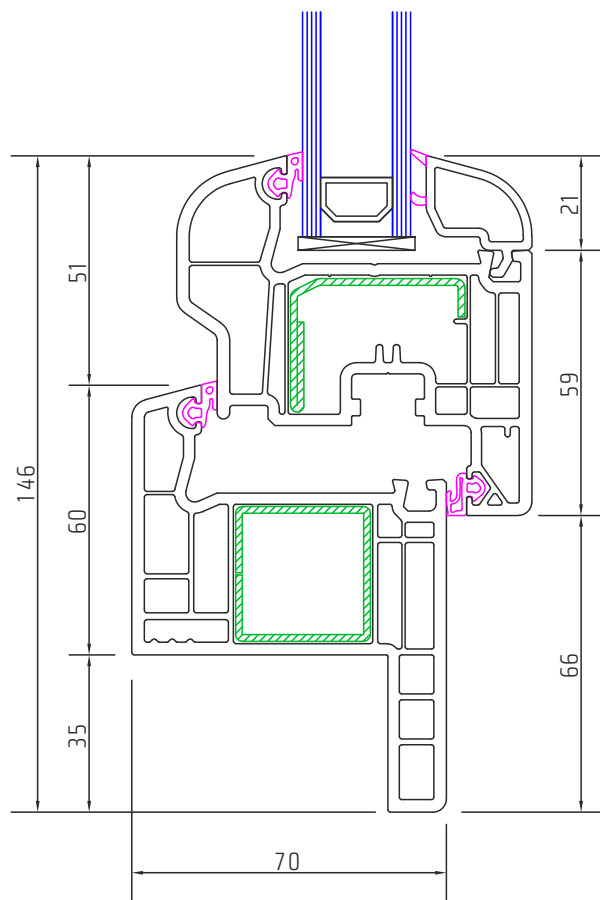

### A65

111.208v0 + 103.236

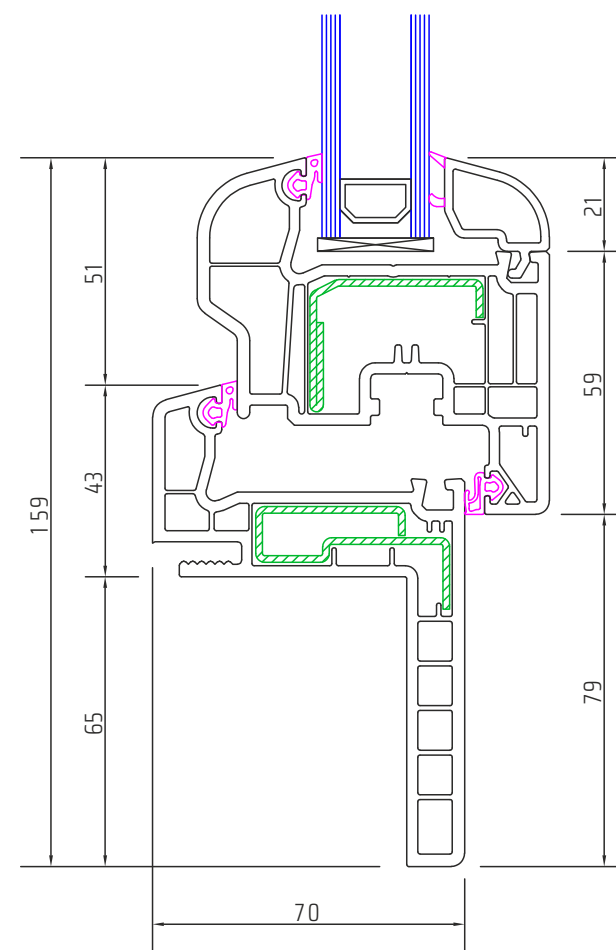

### meneau mobile – poignée décentrée

103.236 + 102.219 + 103.236

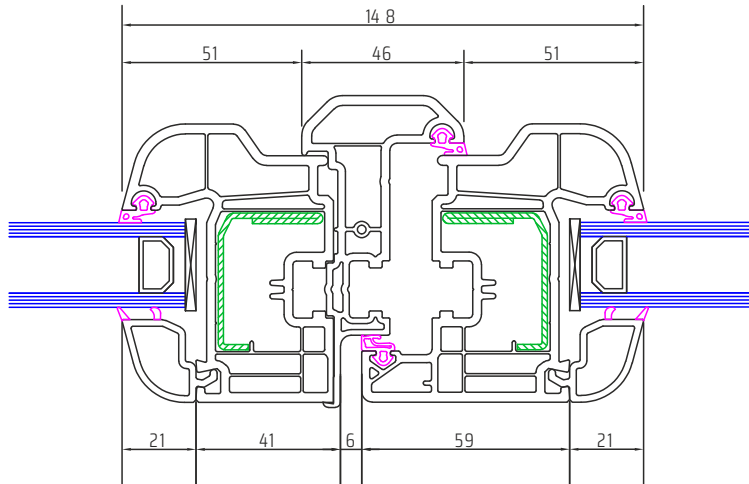

### meneau mobile – poignée centrée avec cache de protection

103.236 + 102.219 + 109.499 + 103.236

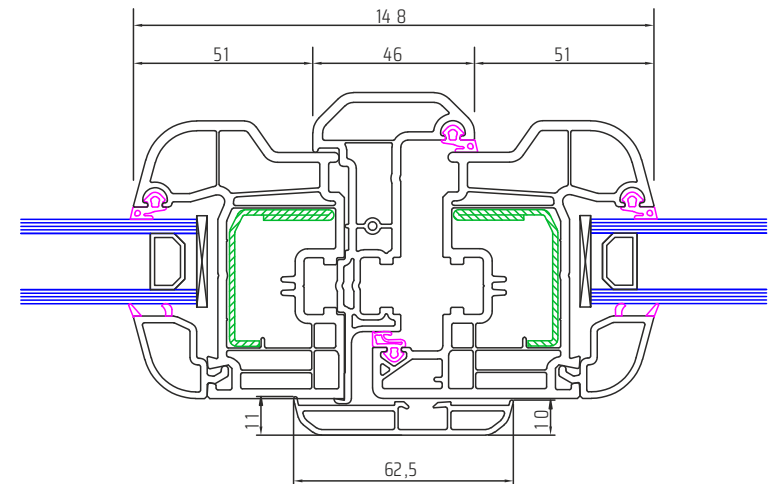

103.236 + 102.236 + 103.236

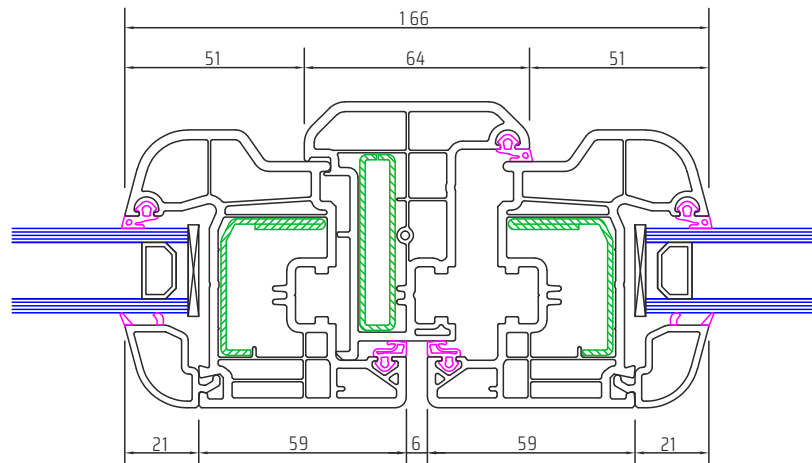

### meneau fixe

103.236 + 102.249 + 103236

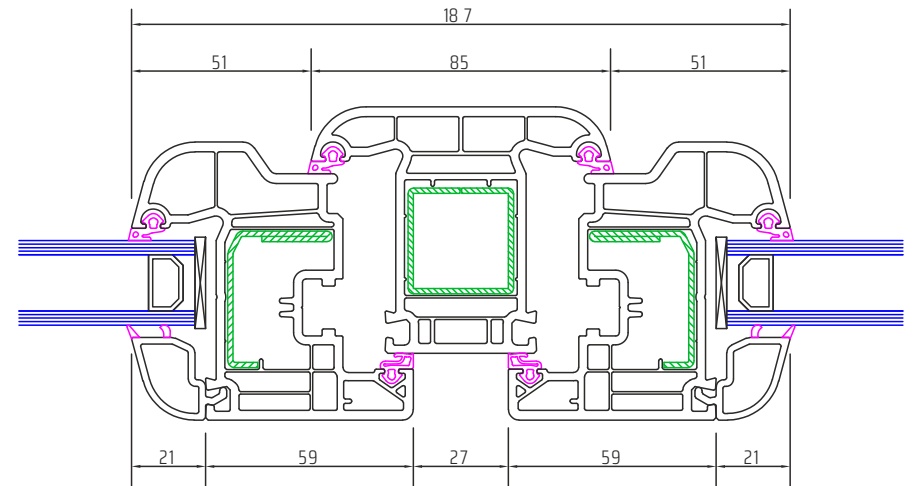



## dormant + ouvrant

101.290 + 103.341

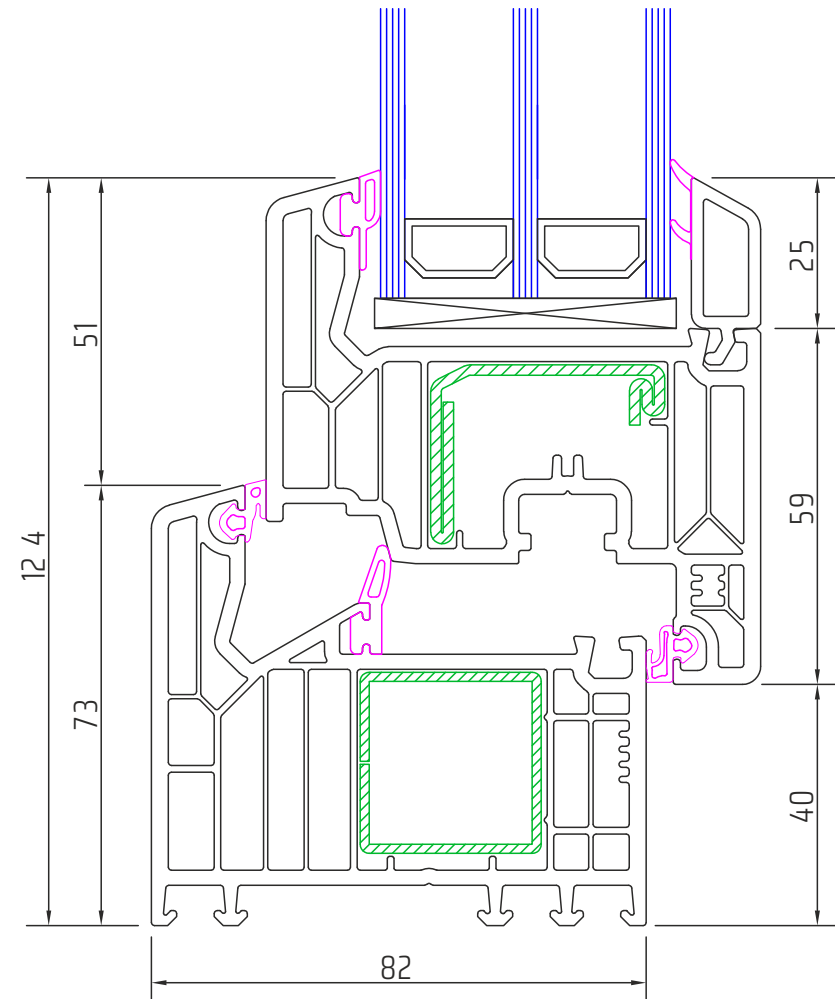



### meneau fixe

103.341+102.314+103.341

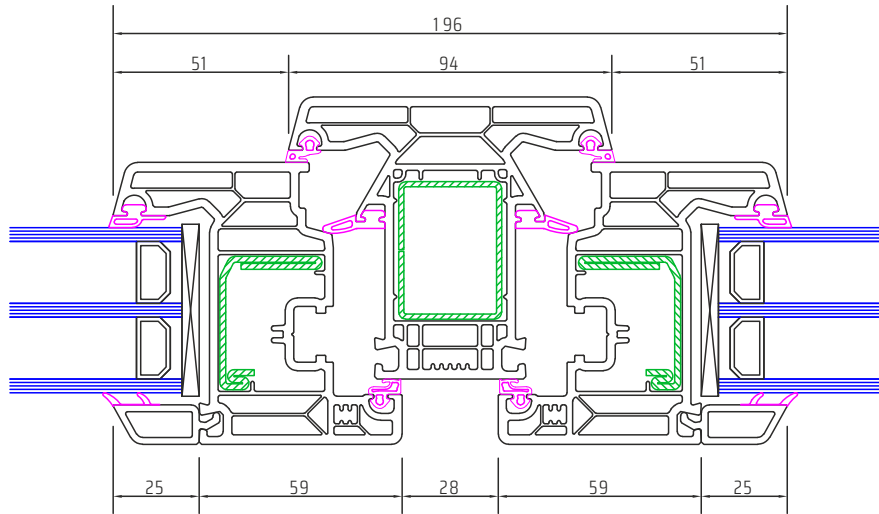

### meneau mobile - poignée décentrée

103.341 + 102.314 + 103.341

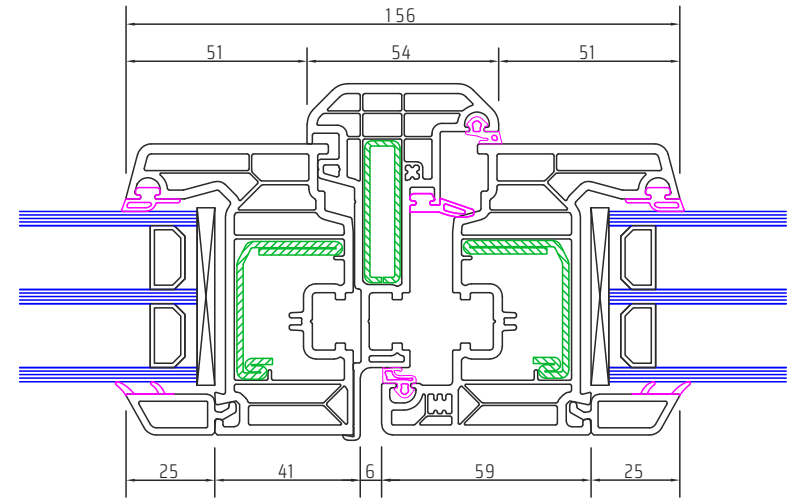

### porte fenêtre seuil plat alu

104.460 + 103.341

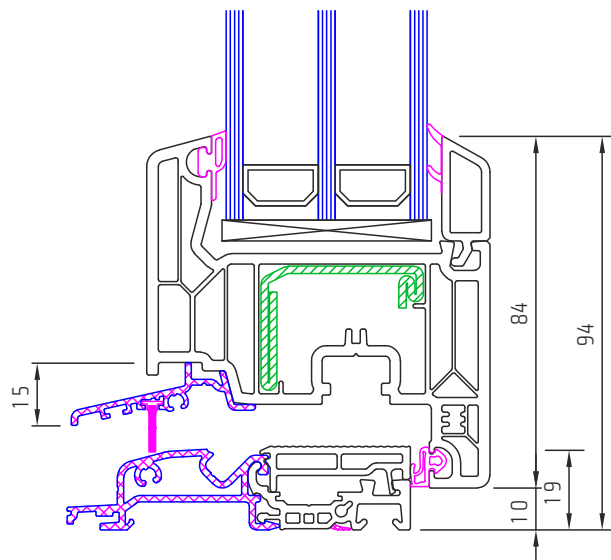

103.341+102.316+103.341

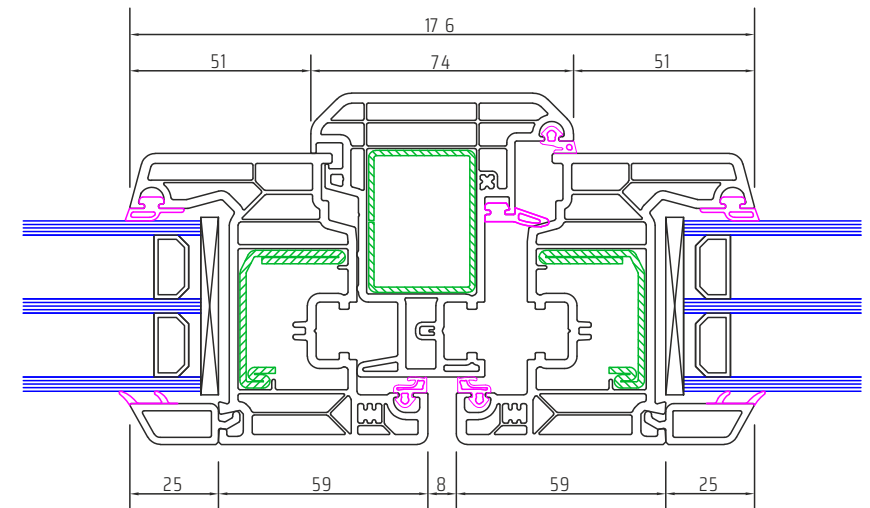

# SOFTLINE 76



dormant + ouvrant

101.350 + 103.381

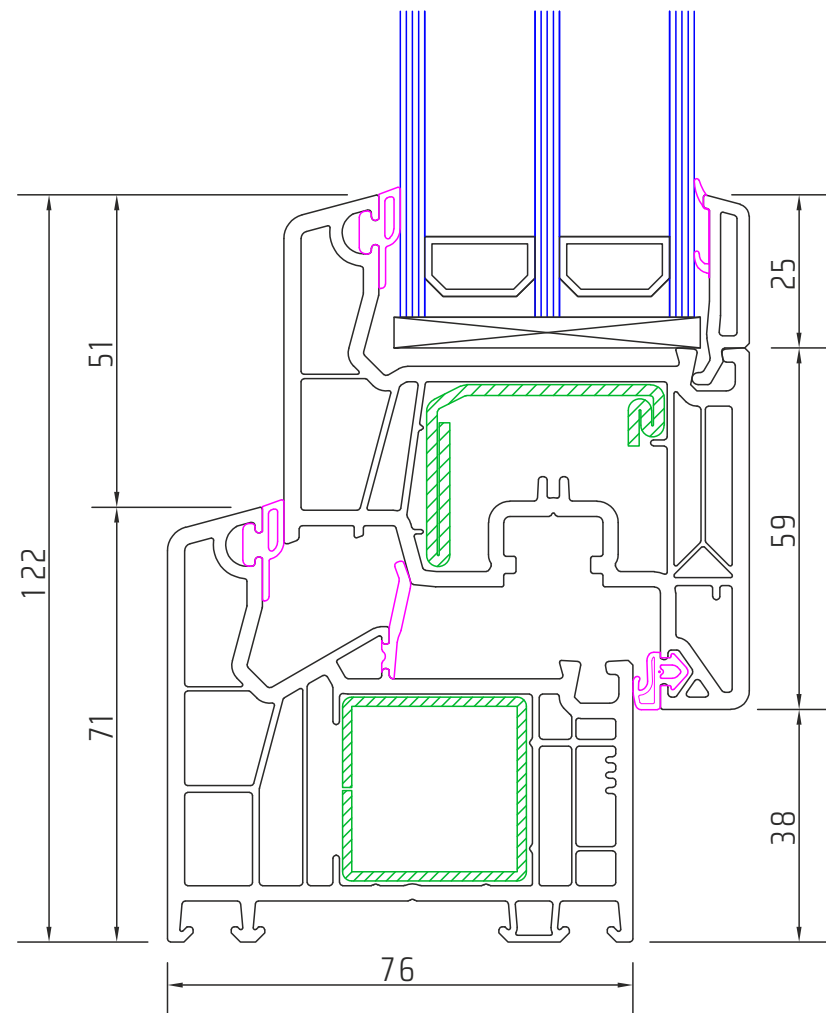

### meneau fixe

103.381 + 102.350 + 103.381

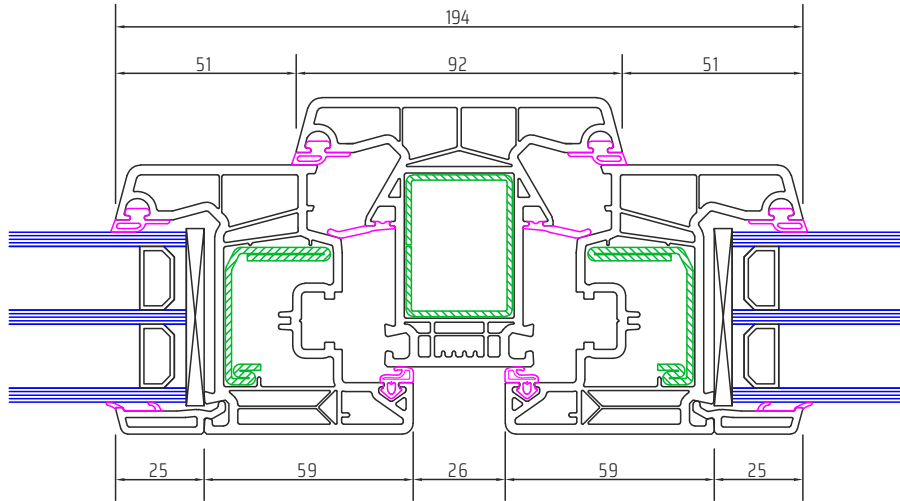

### meneau mobile - poignée décentrée

103.381 + 102.354 + 103.381

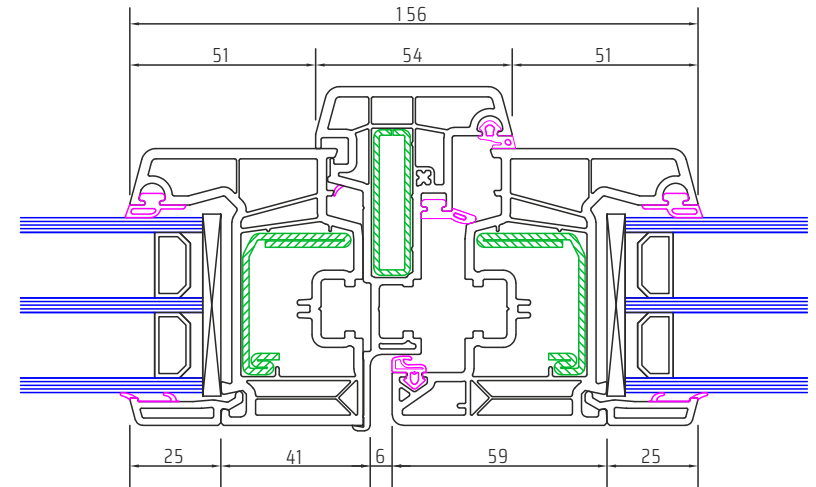

### porte fenêtre seuil plat alu

104.530 + 103.381

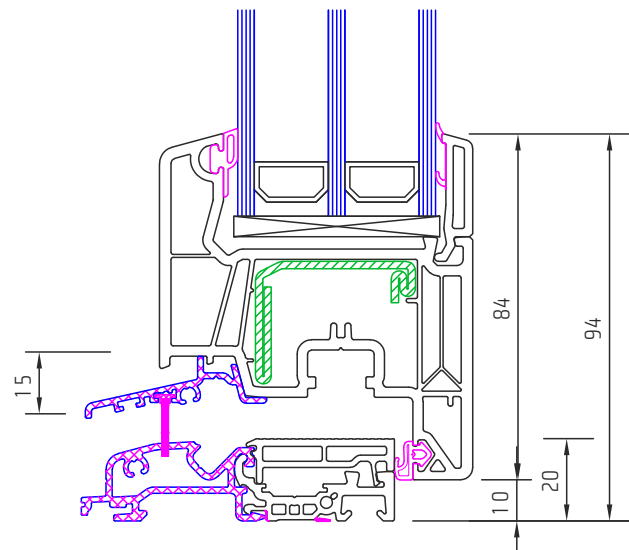

103.381 + 102.356 + 103.381

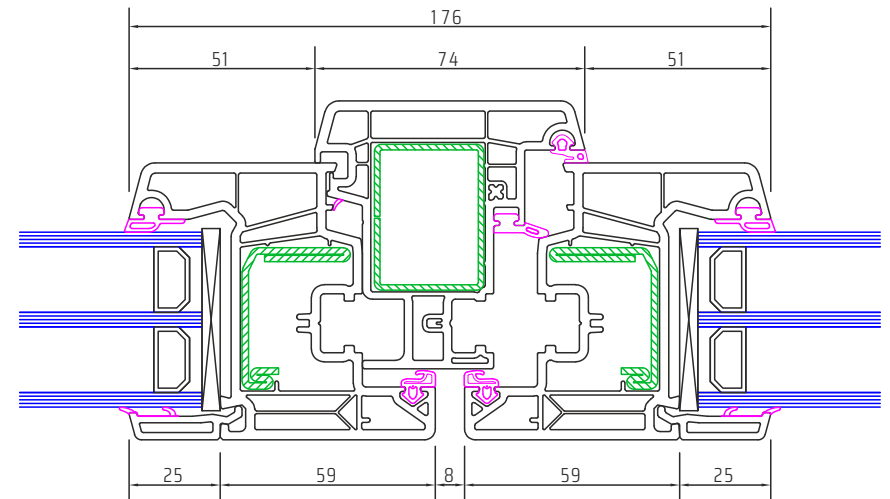

# ACCESSOIRES Compatibles EFECTLINE, PERFECTLINE, S-LINE, SWINGLINE, SOFTLINE 82, SOFTLINE 76

## Elargisseurs profile 70 mm

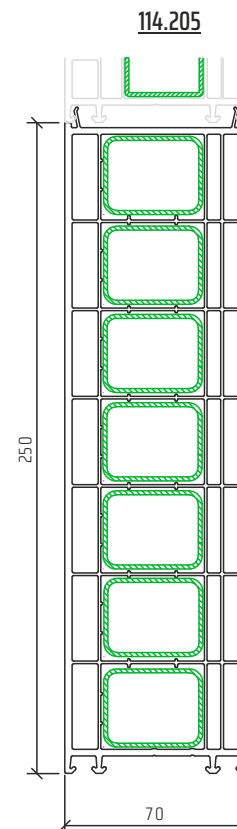
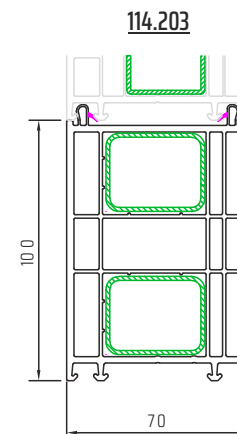
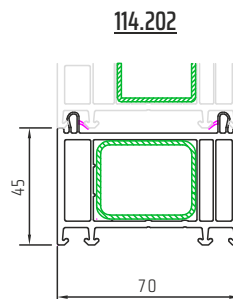
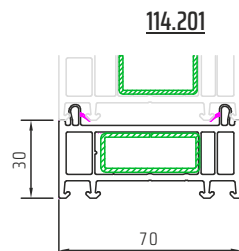
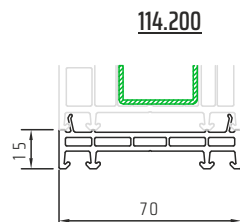

## Elargisseurs profile 76 mm

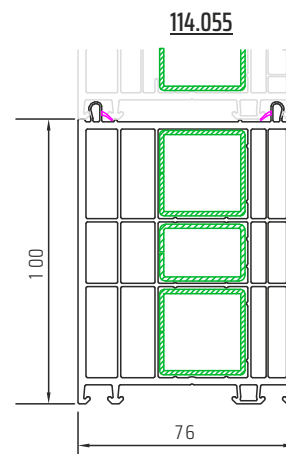
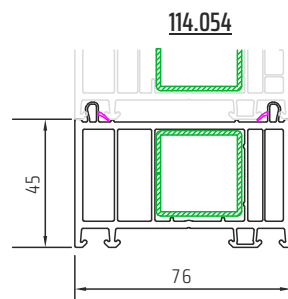
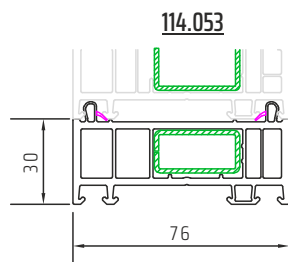
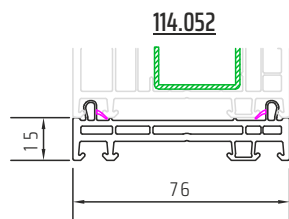

## Elargisseurs profile 82 mm

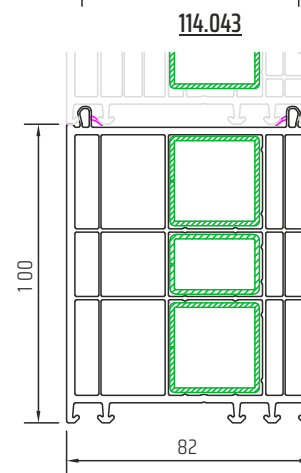
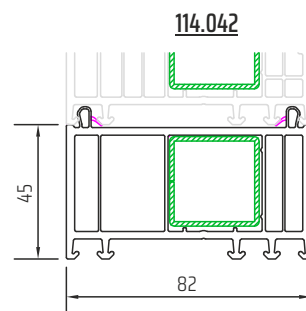
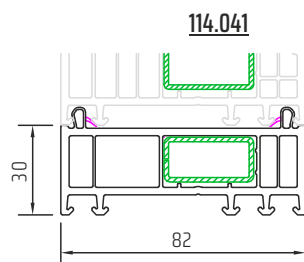
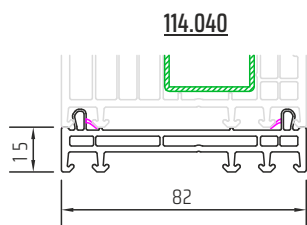

## Elargisseurs porte fenêtre profile 70 mm

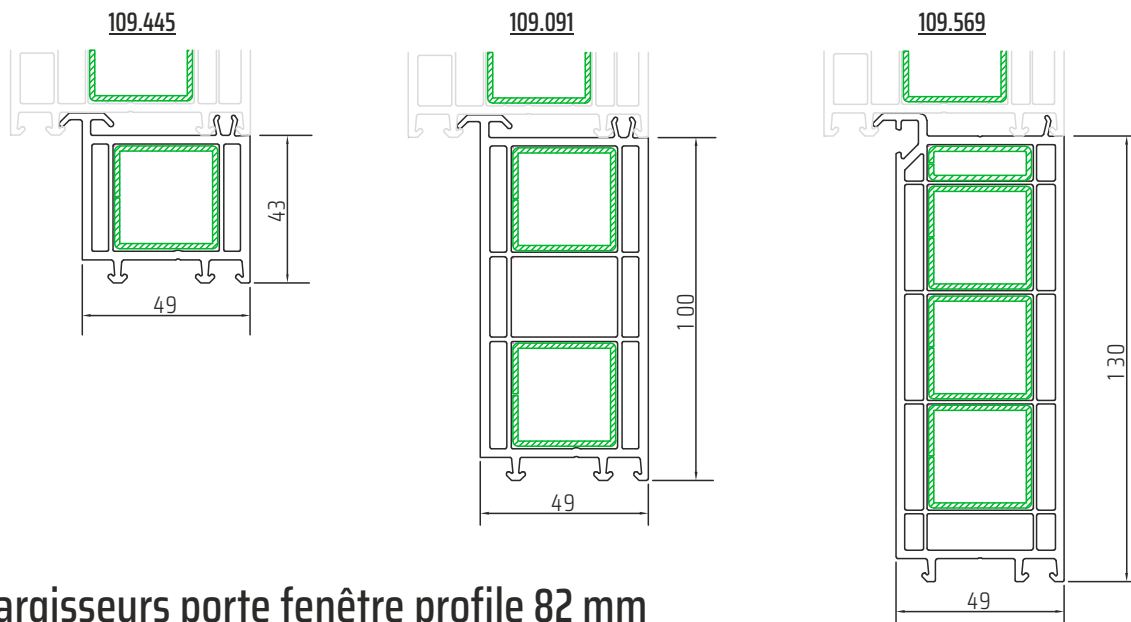

## Elargisseurs porte fenêtre profile 82 mm

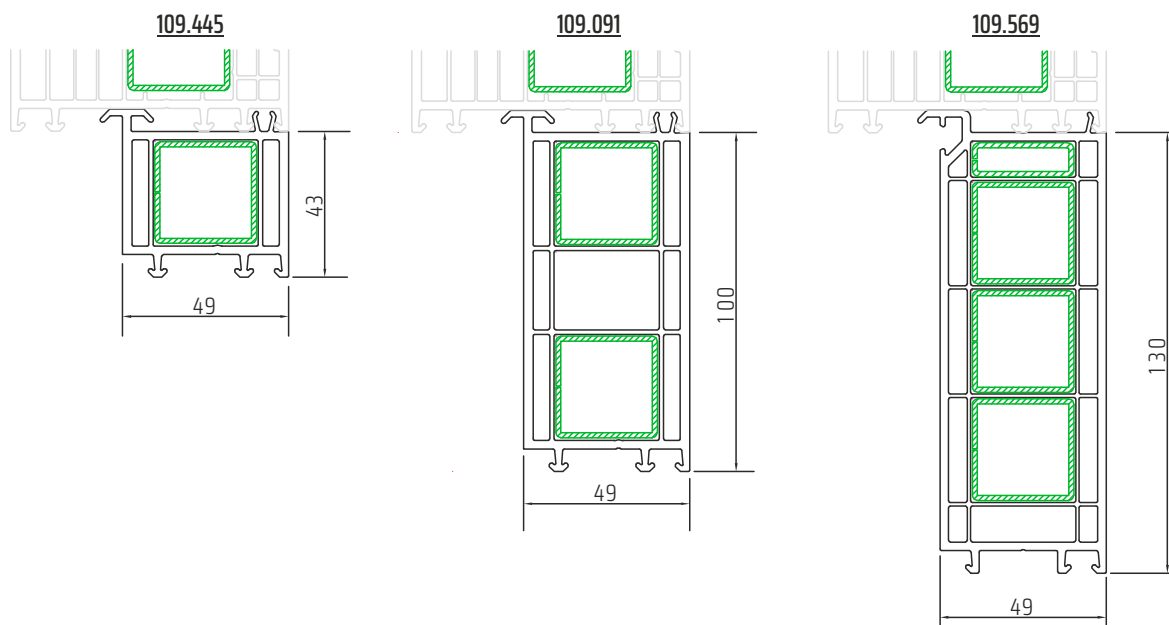

## Elargisseurs porte fenêtre profile 76 mm

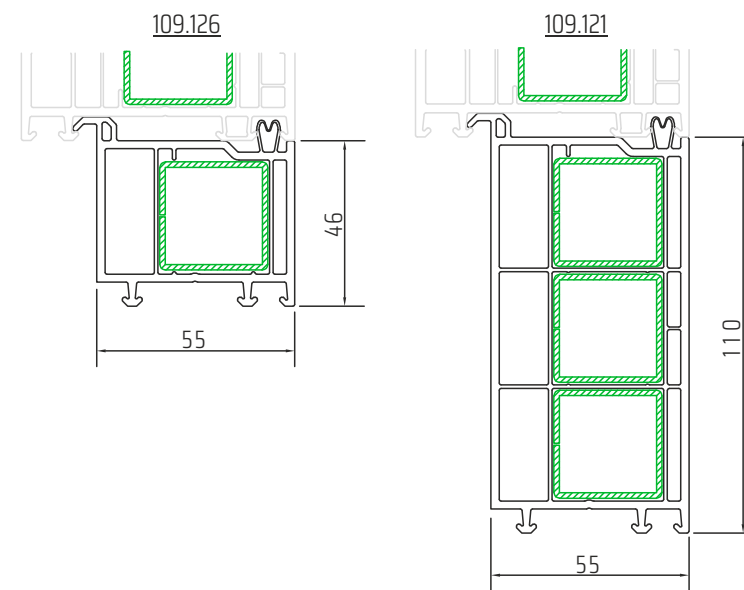

## Pièces d'appuis RENO

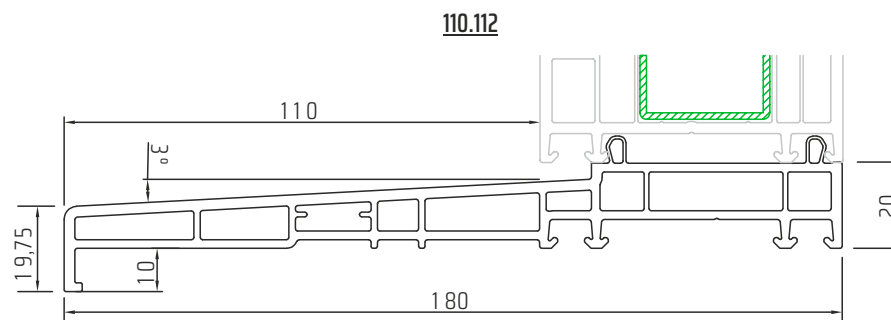
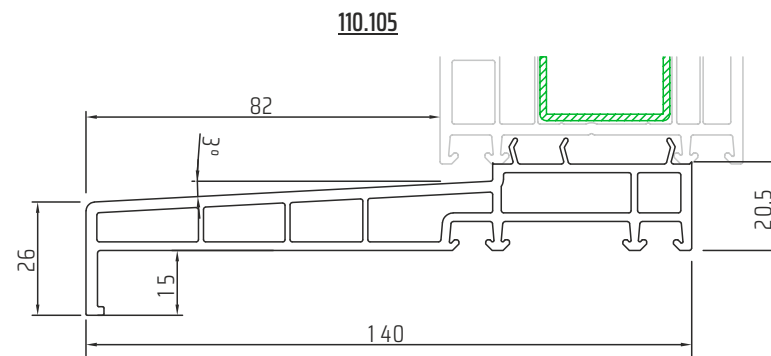
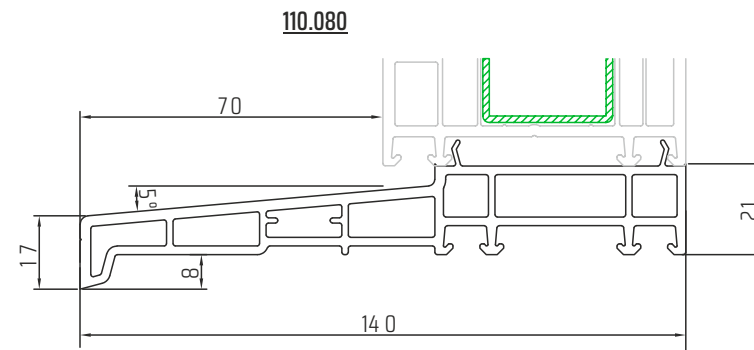
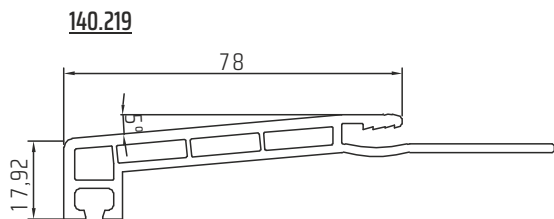

## Tapées

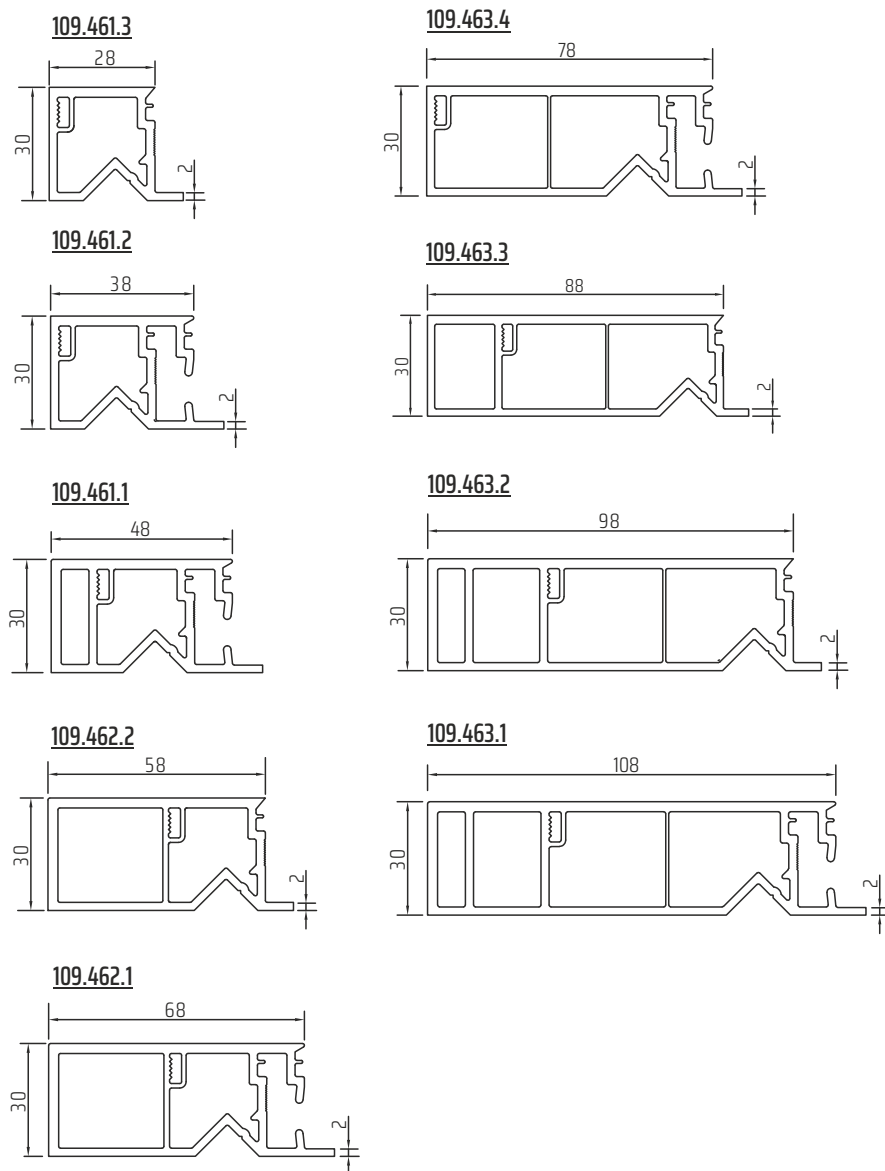

## Ailes rapportées / pièces d'appuis

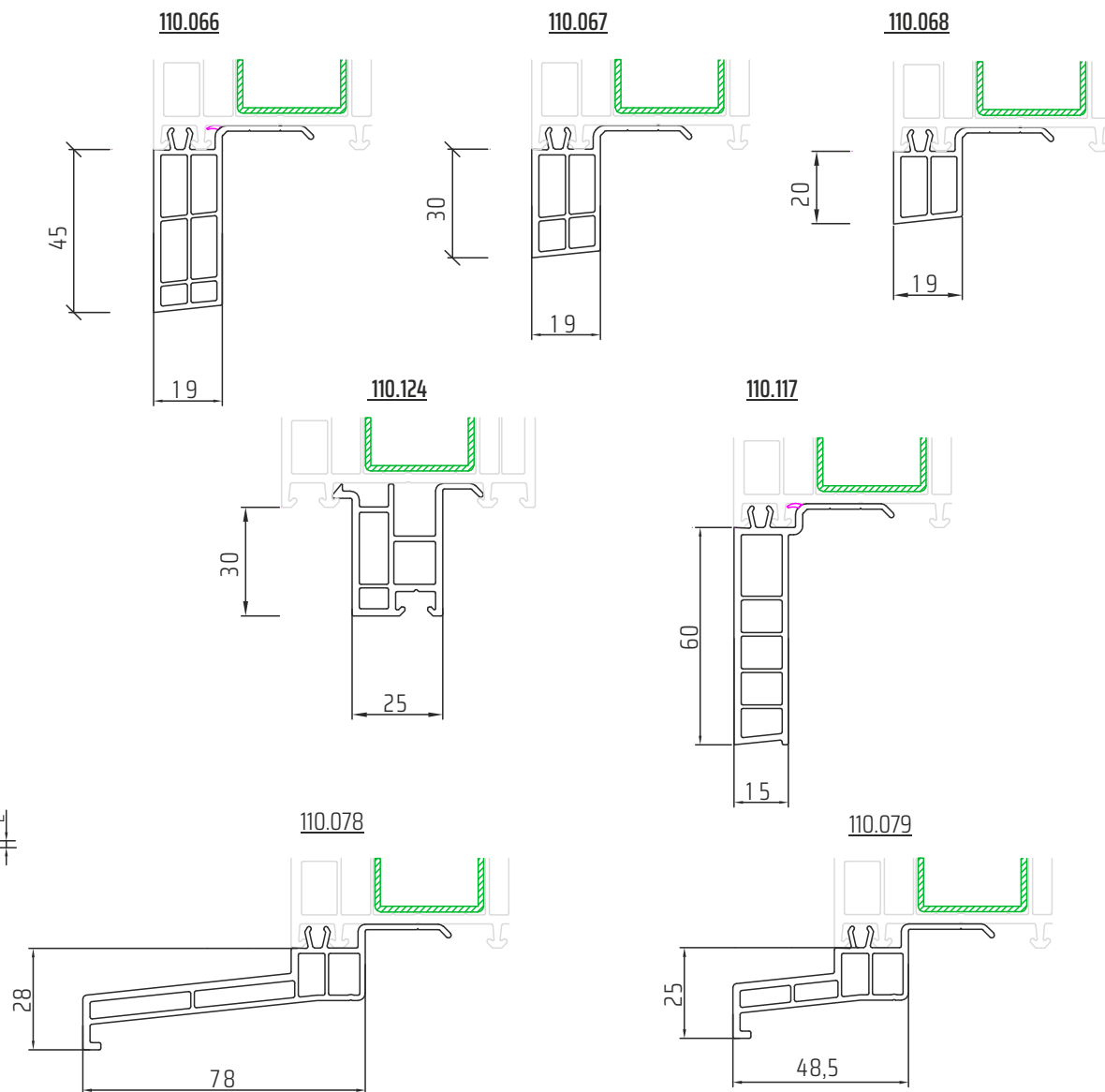

## Accouplements profile 70 mm

mini accouplement horizontal

116.217

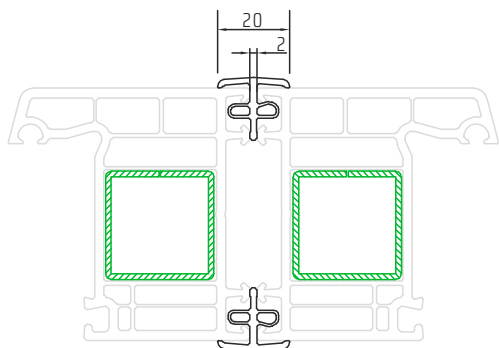

mini accouplement horizontal

111.230

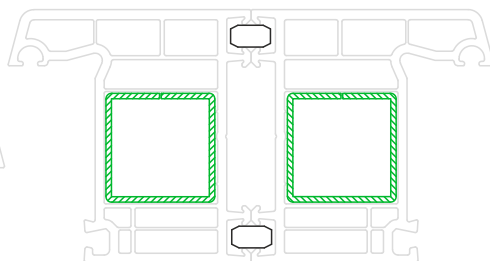

116.201

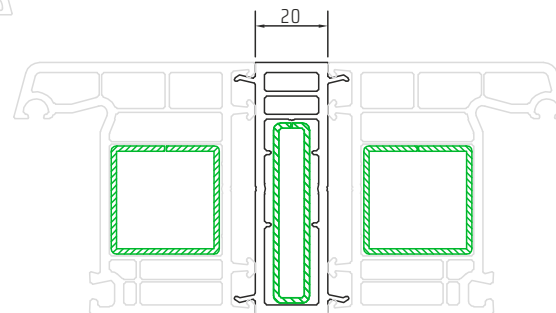

116.028/116.029

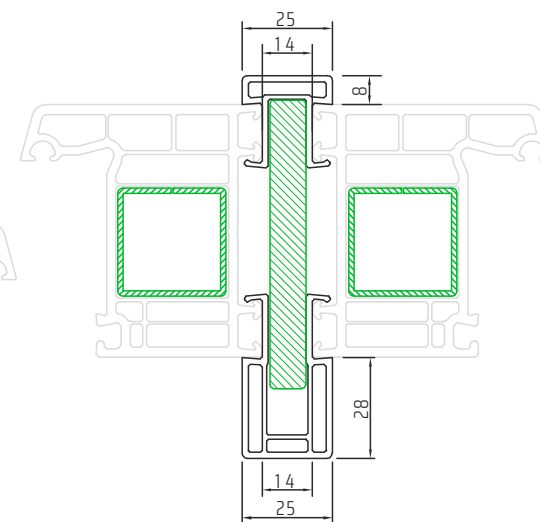

accouplement 90'

116.218

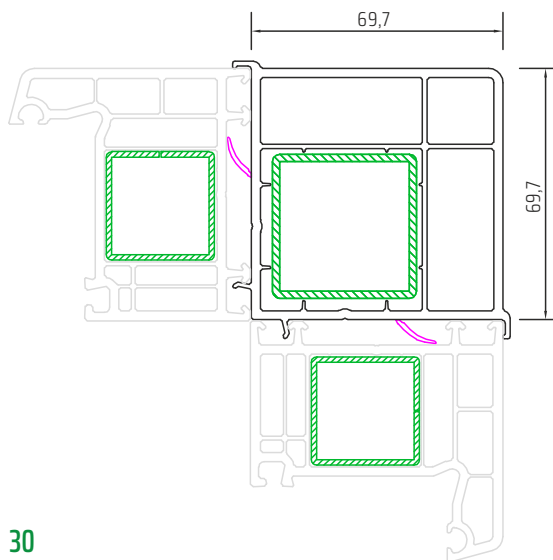

accouplement 135'

116.226

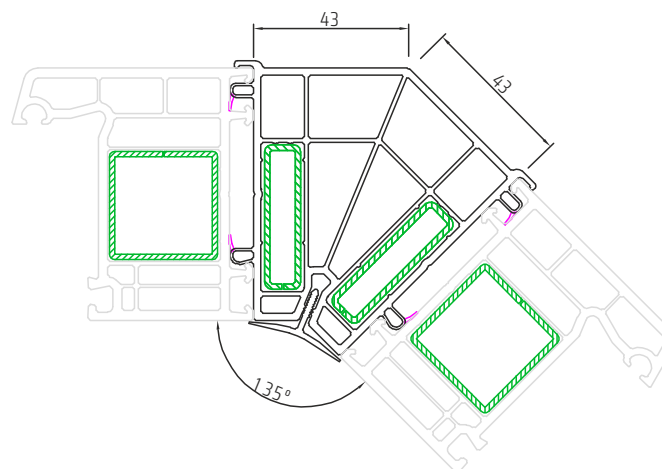

accouplement à angle variable

116.205/116.206

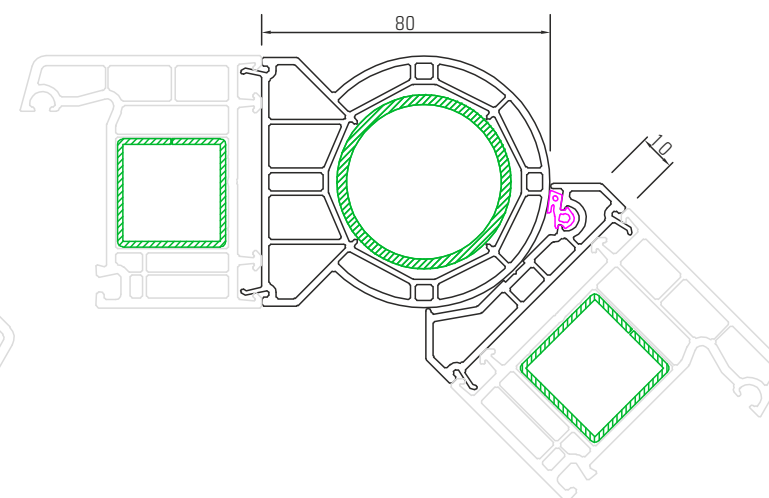



## Accouplements profile 76 mm

mini accouplement horizontal

116.217

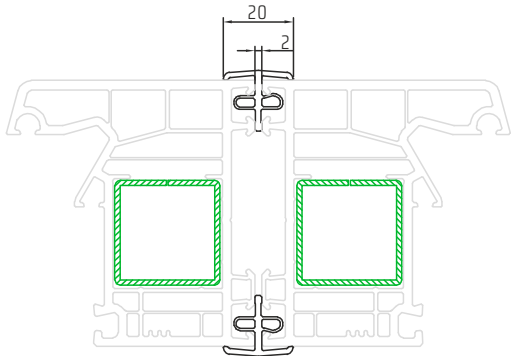

mini accouplement horizontal

111.230

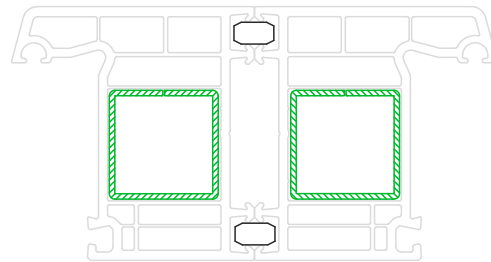

116.230

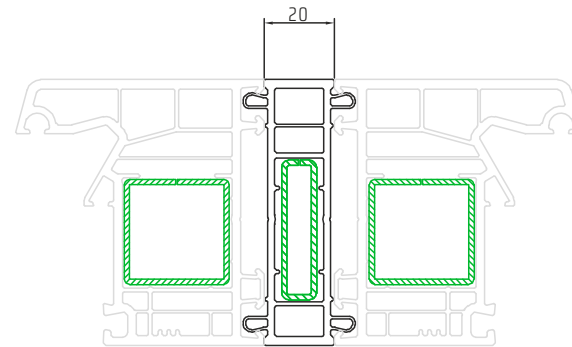

accouplement 90°

116.229

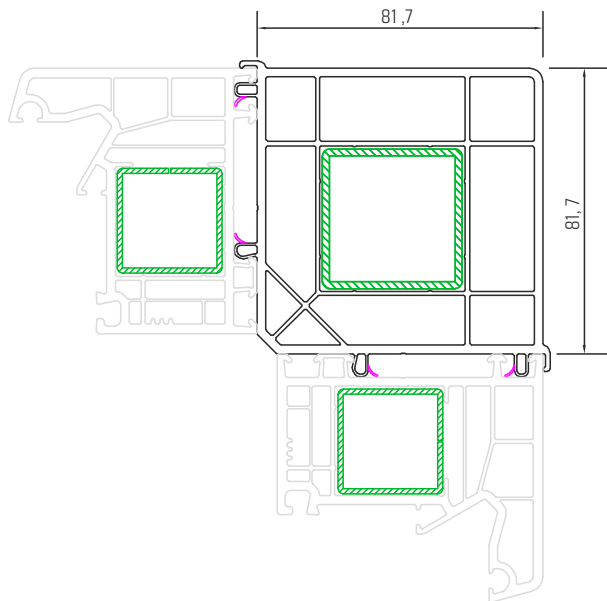

116.226

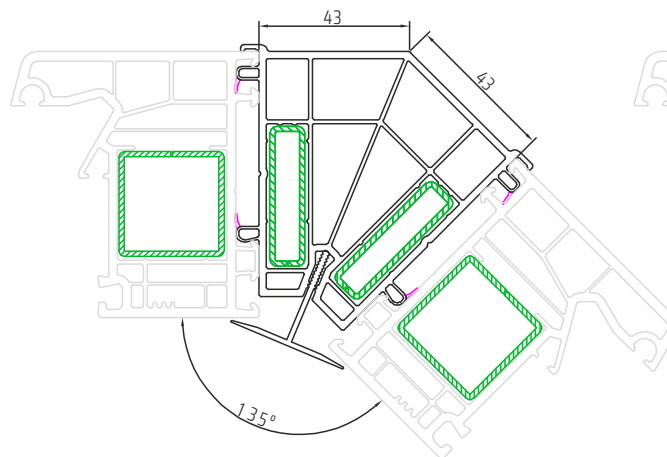

accouplement à angle variable

116.215/116.216

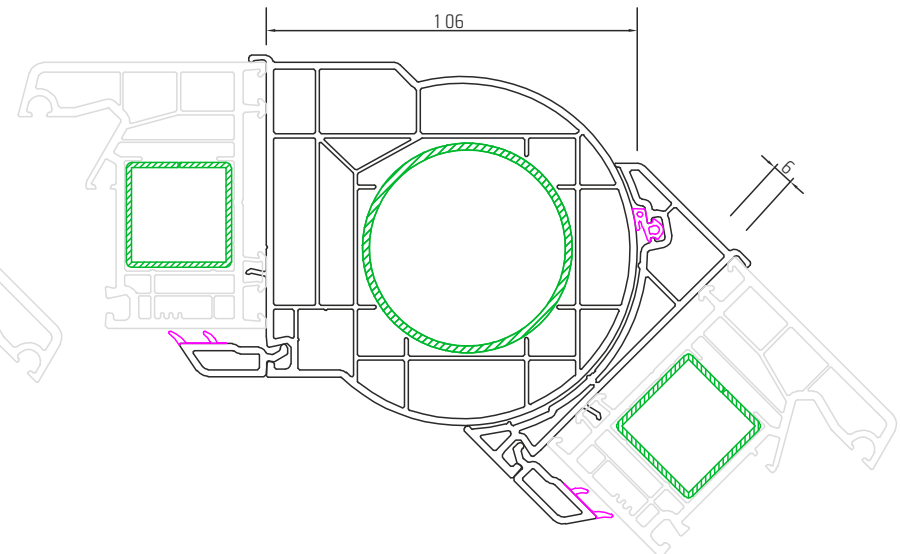

## Accouplements profile 82 mm

mini accouplement horizontal

116.217

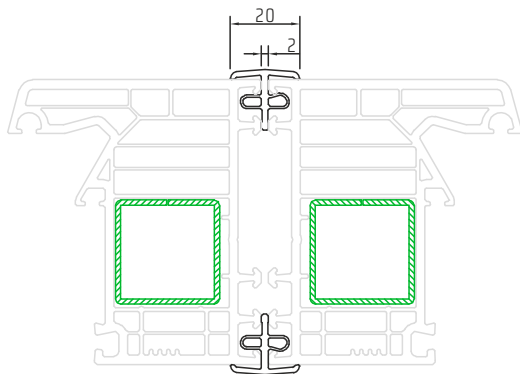

mini accouplement horizontal

111.230

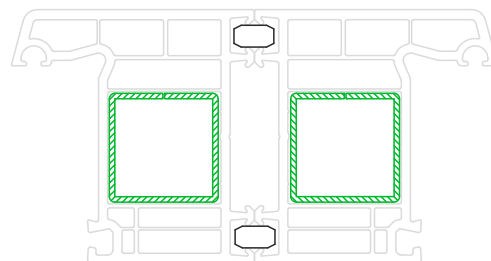

116.219

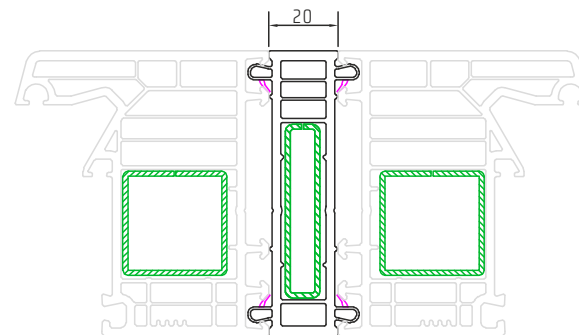

accouplement 90'

116.229

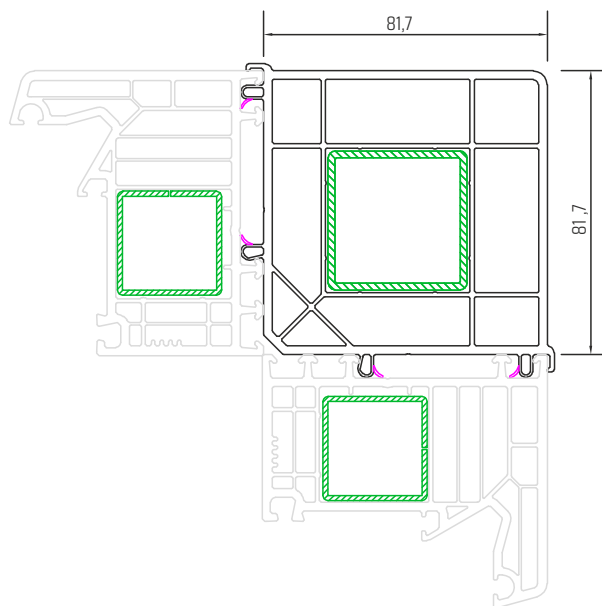

116.226

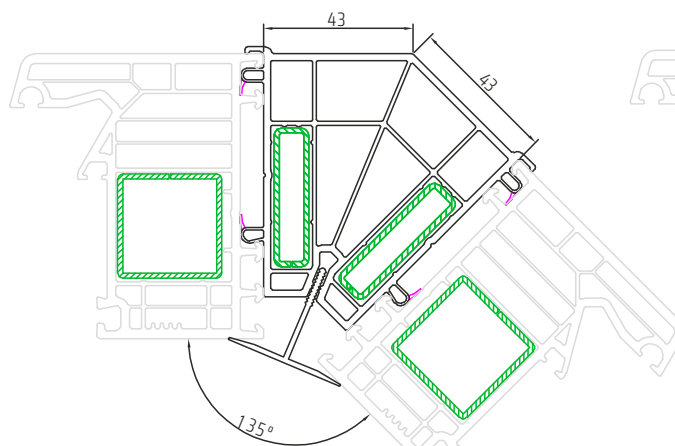

accouplement à angle variable

116.215/116.216

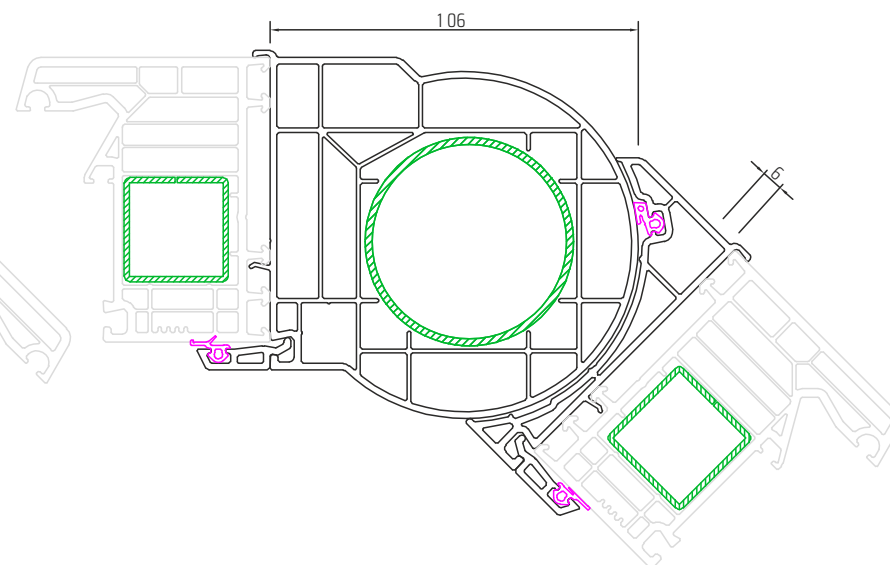

## Accouplements de dilatation - vertical/horizontal

**A1.1**  
116.210/116.210

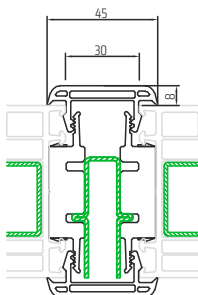

**A 1.1 pour VR**  
116.210/116.213

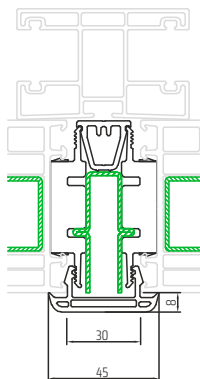

**A 1.2**  
116.210/116.210

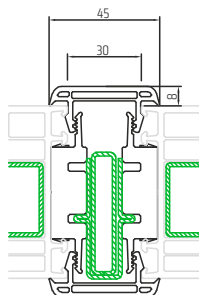

**A 1.2 pour VR**  
116.210/116.213

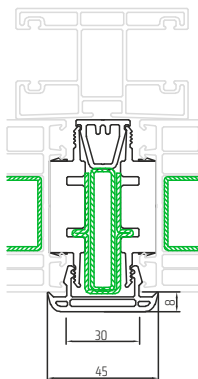

**A 1.3**  
116.210/116.210

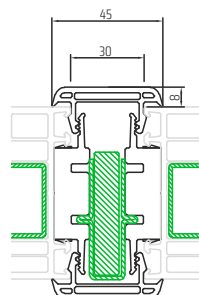

**D 3.0**  
116.211/116.212

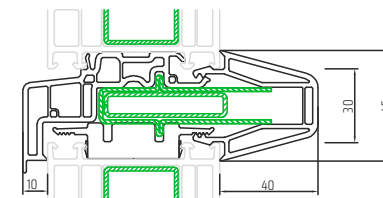

**D 1.1**  
116.211/116.212

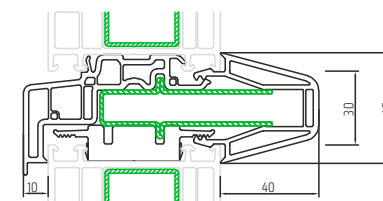

**B 1.0**  
116.211/116.210

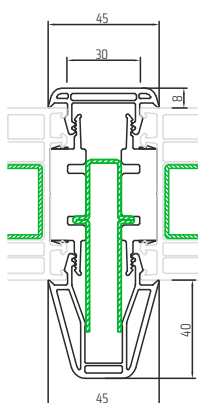

**B 1.0 pour VR**  
116.211/116.213

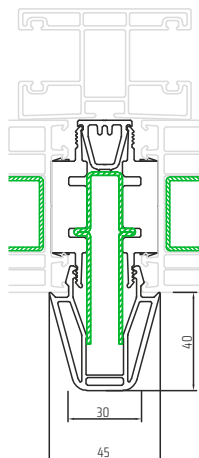

**B 1.1**  
116.211/116.210

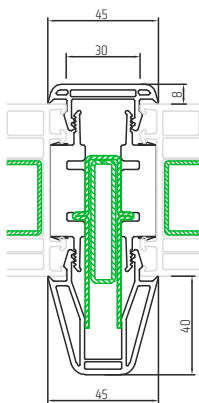

**B 1.1 pour VR**  
116.211/116.213

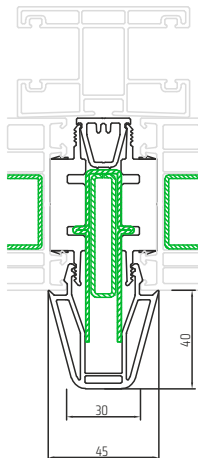

**B 1.2**  
116.211/116.210

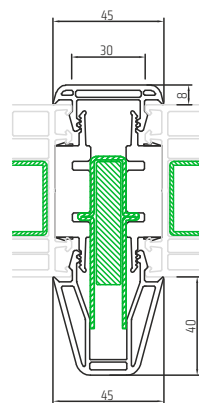

**B 1.3**  
116.211/116.210

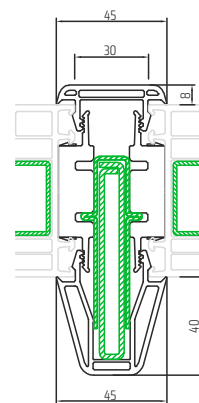

**B 1.4**  
116.211/116.210

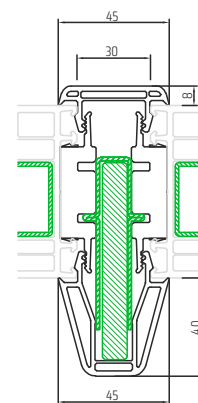

**D 1.0**  
116.210/116.212

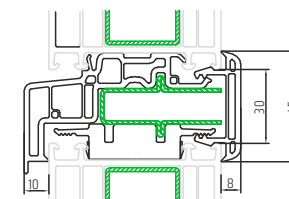

## Parcloses carrées

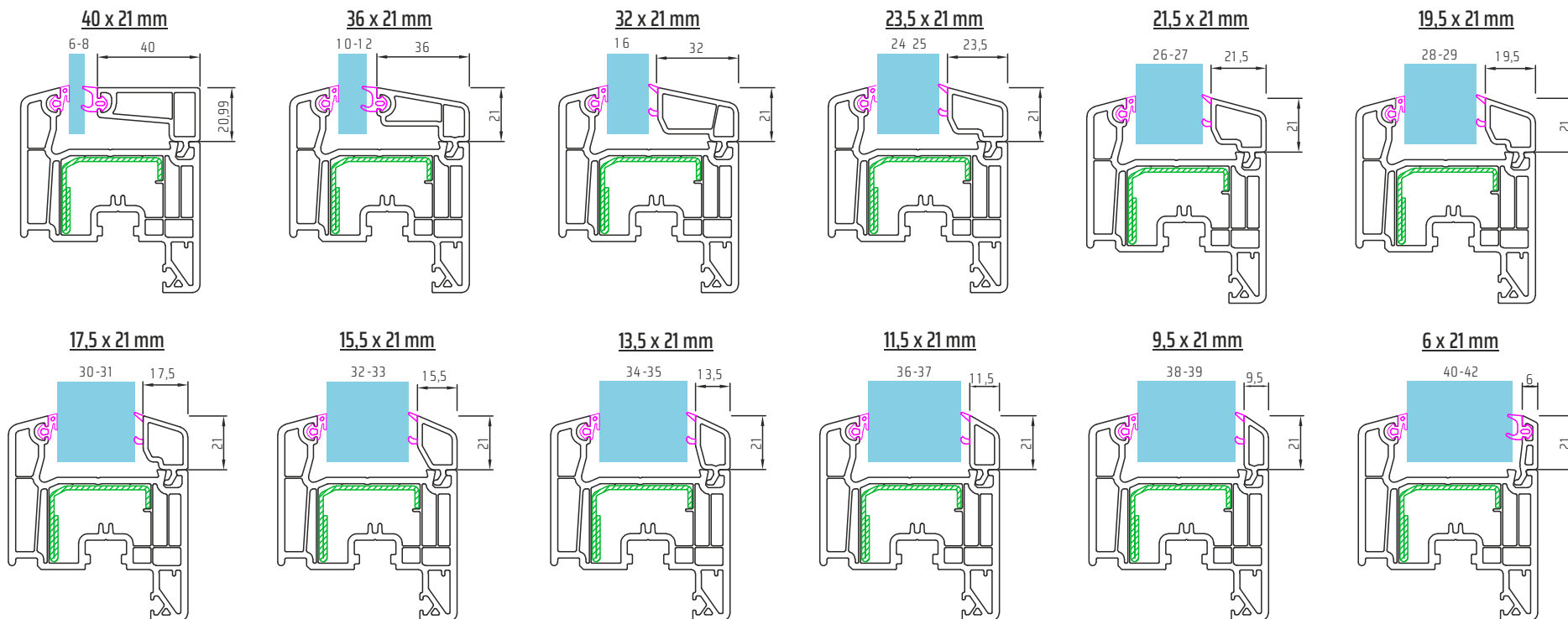

## Parcloses arrondies

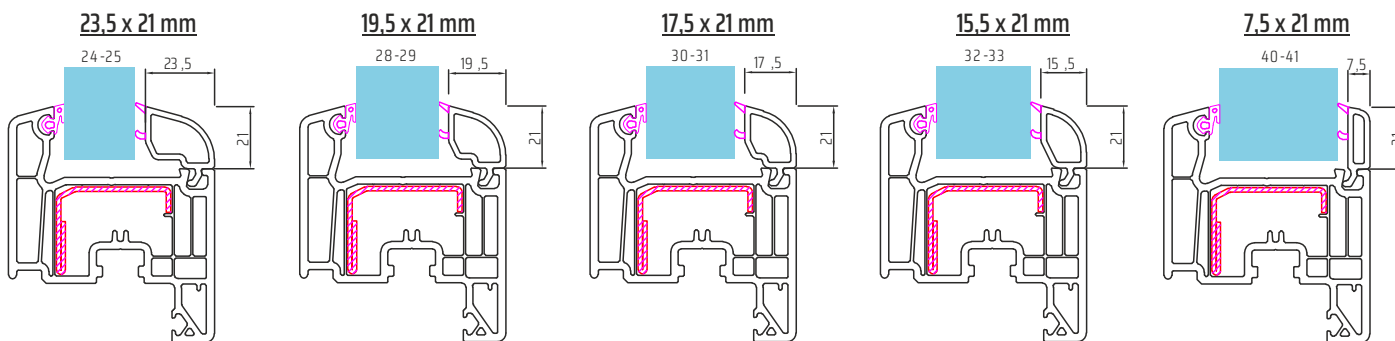

## Parcloses moulurées

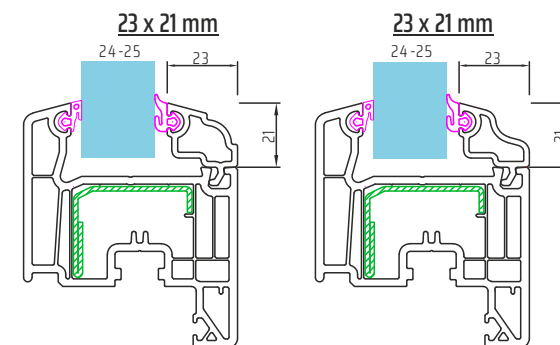

## Parclores 76



## Parcloses 82



## Plats de finition

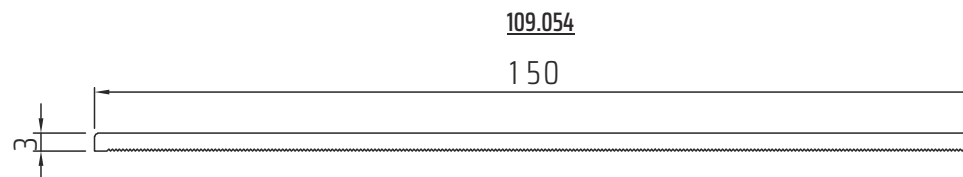
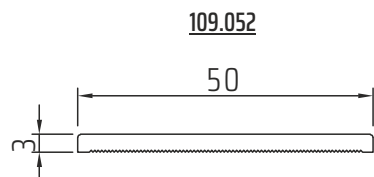
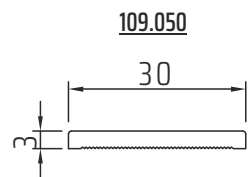

## Cornières

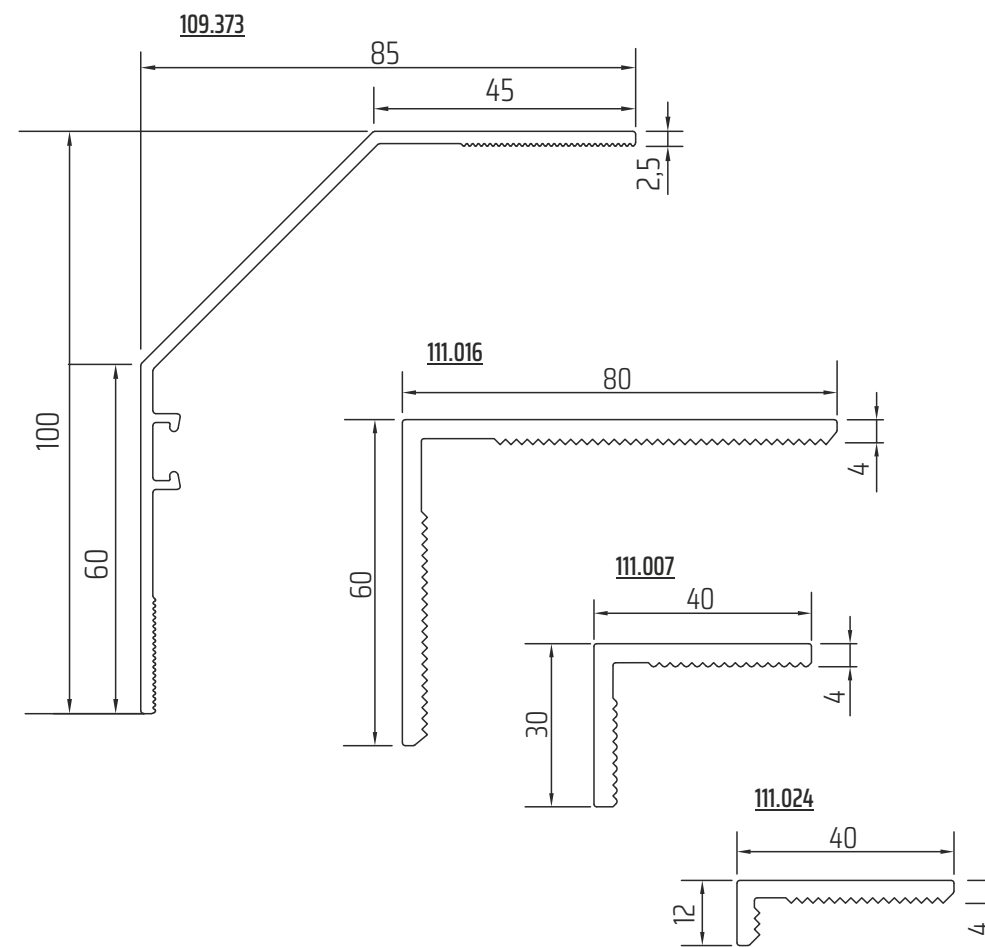
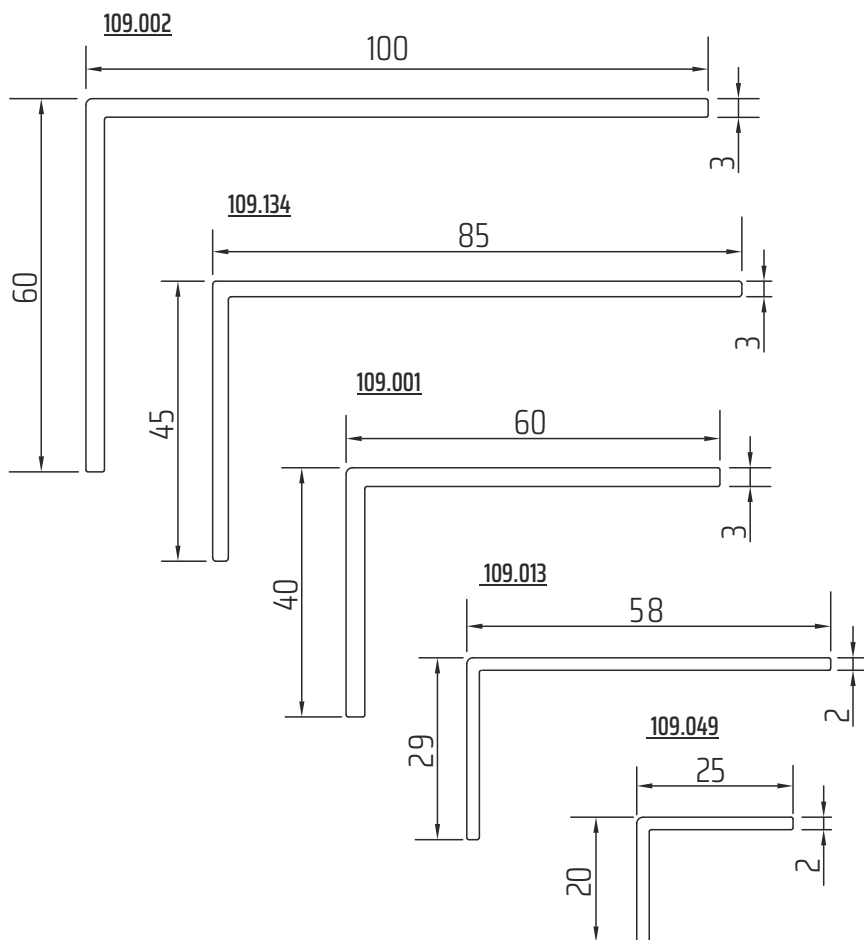

# PORTES D'ENTREE OUVRANT 120 mm

Perfectline

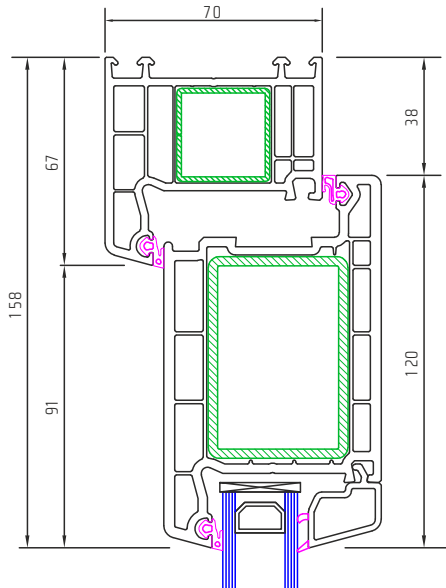

104.427 + 105.232 + 101.208

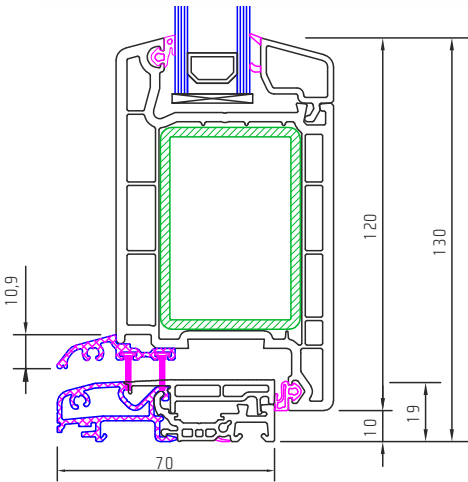

ouverture vers l'extérieur

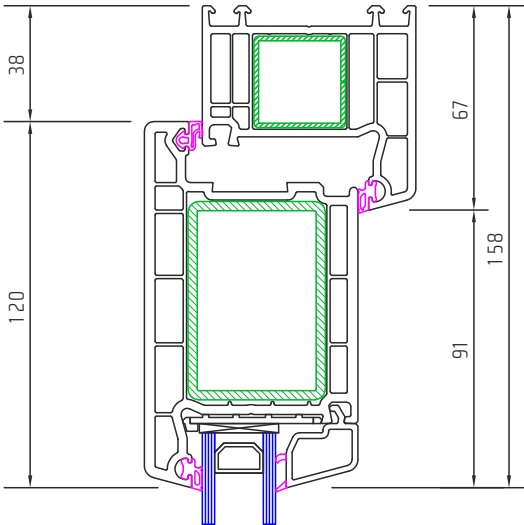

104.427 + 105.233 + 101.208

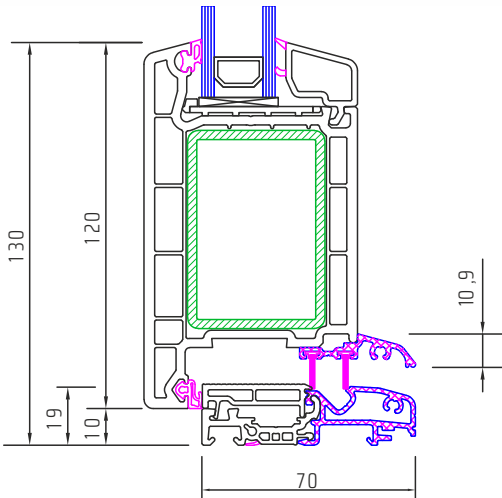

Softline RENO 35

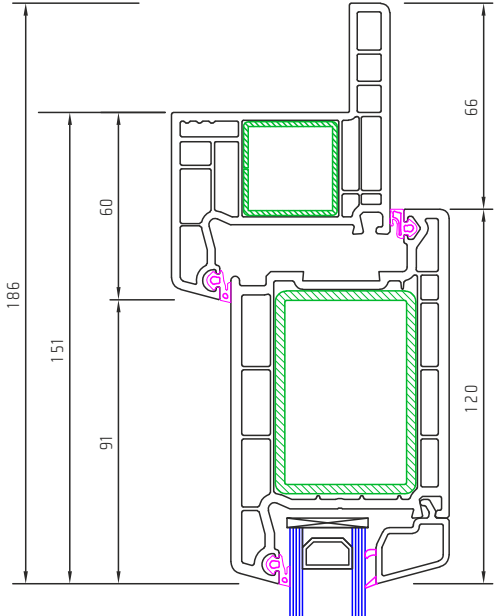

104.427 + 105.232 + 101.218

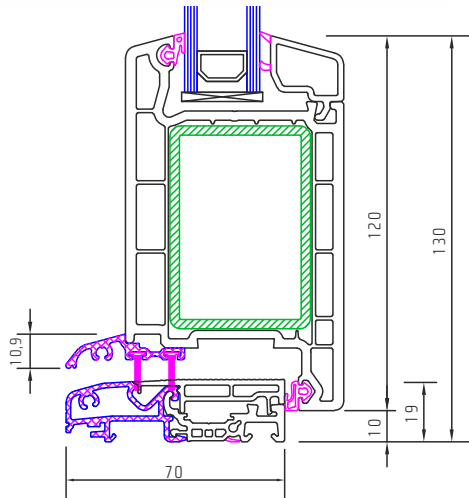



# PORTES D'ENTREE OUVRANT 125 mm

Softline 76

ouverture vers l'extérieur

Softline 82

ouverture vers l'extérieur

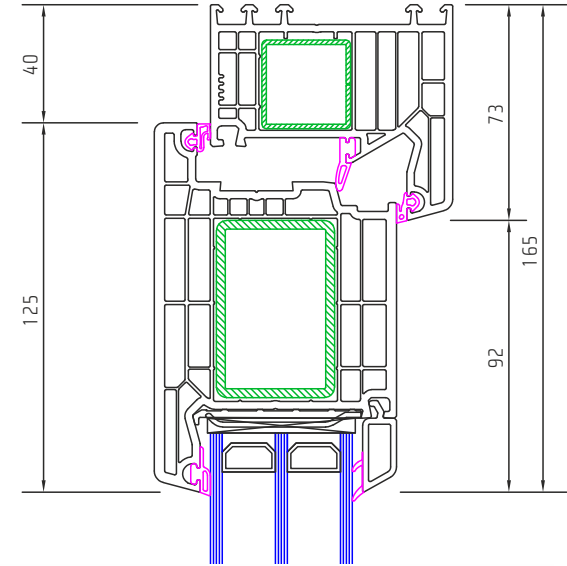
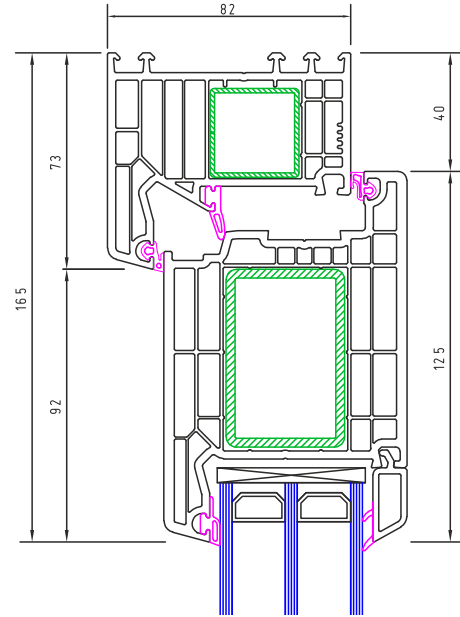
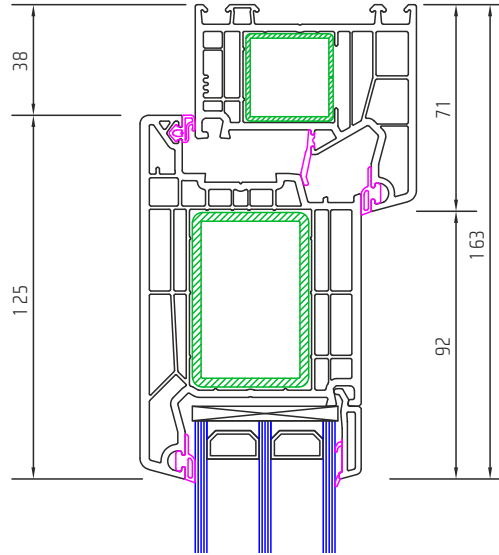
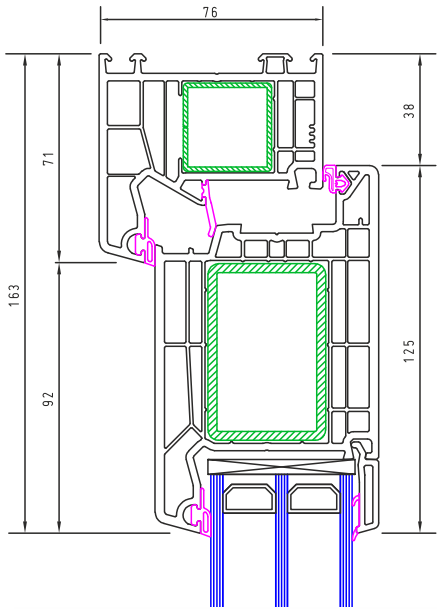

104.530 + 105.400 + 101.350

104.530 + 105.401 + 101.350

104.460 + 105.380 + 101.290

104.460 + 105.381 + 101.290

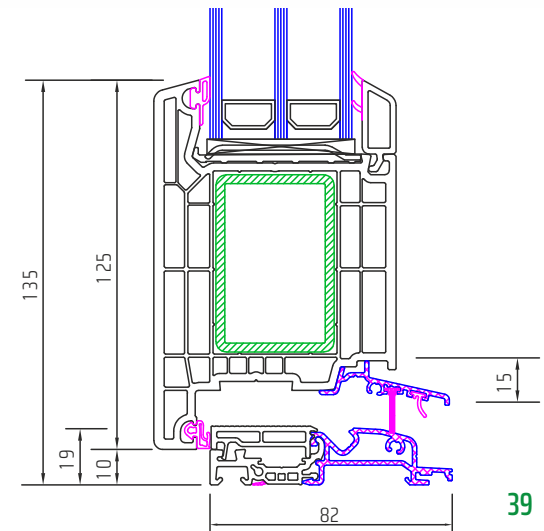
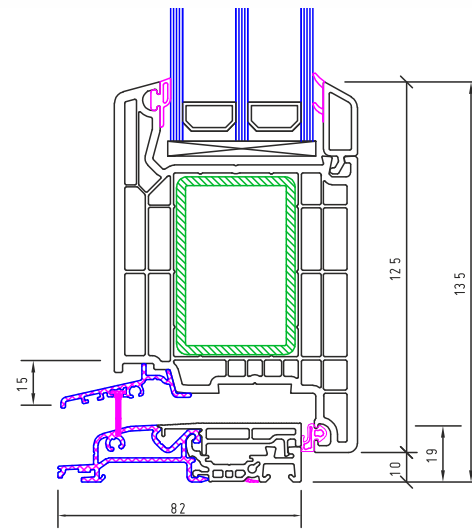
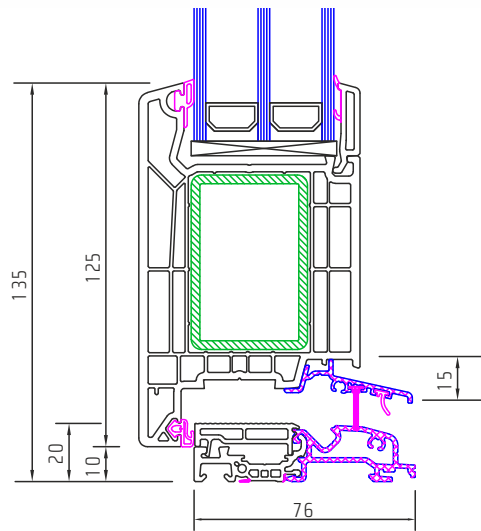
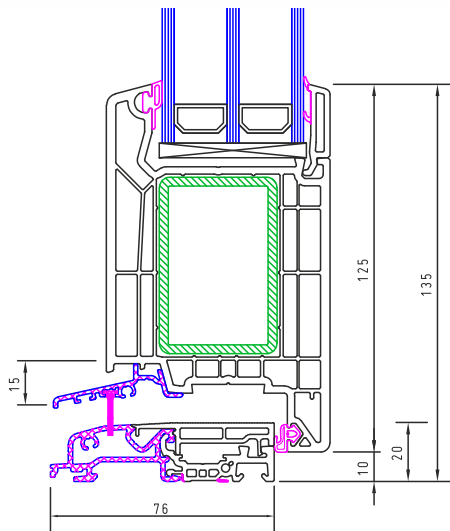

# PORTES DE SERVICE OUVRANT 105 mm

## Perfectline

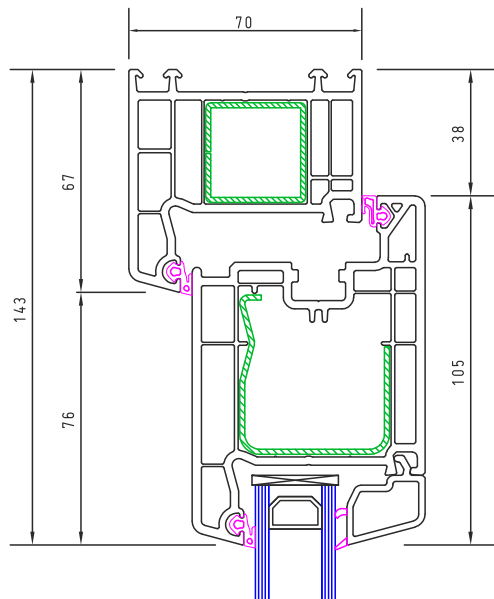

104.427 + 103.241 + 101.208

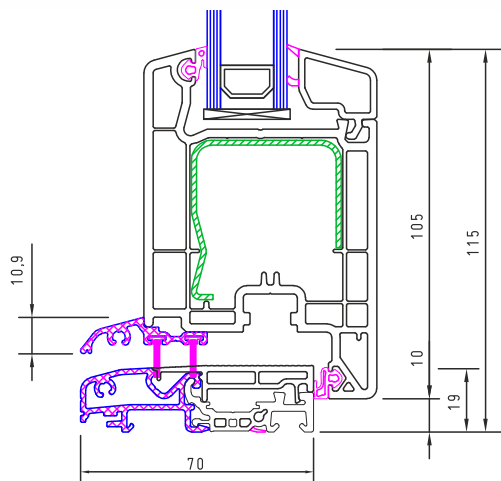

## ouverture vers l'extérieur

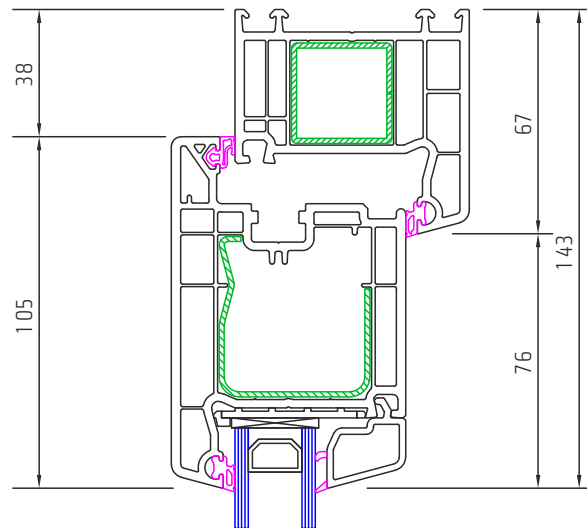

104.427 + 103.242 + 101.208

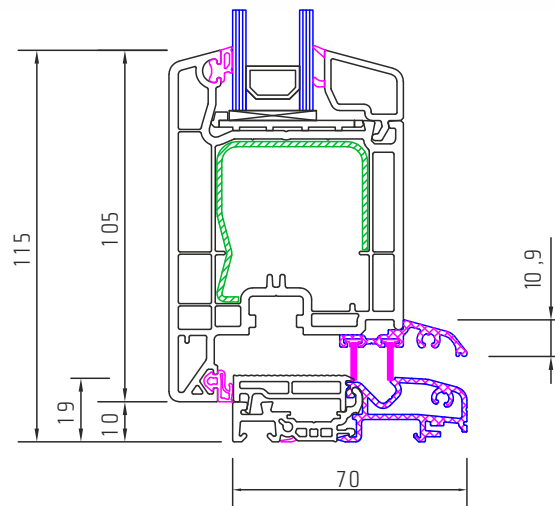

## RENO 35

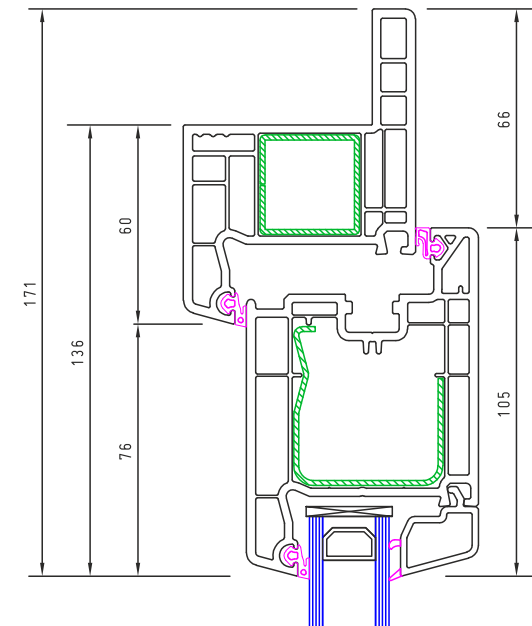

104.427 + 103.241 + 101.218

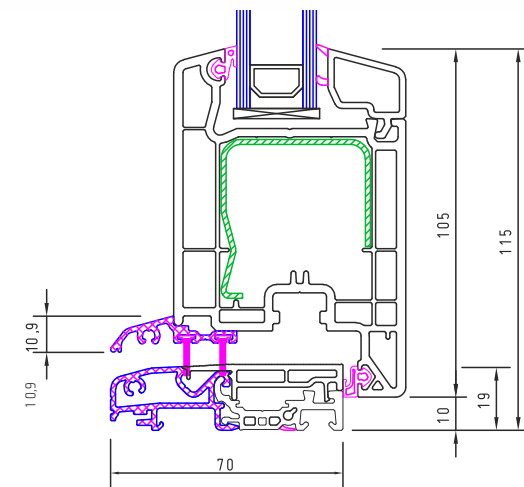

# PORTES D'ENTREE OUVRANT 114 mm

Softline 76

ouverture vers l'extérieur

Softline 82

ouverture vers l'extérieur

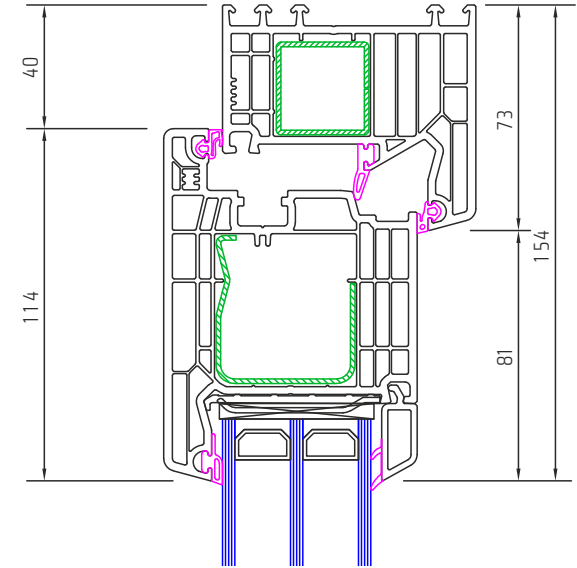
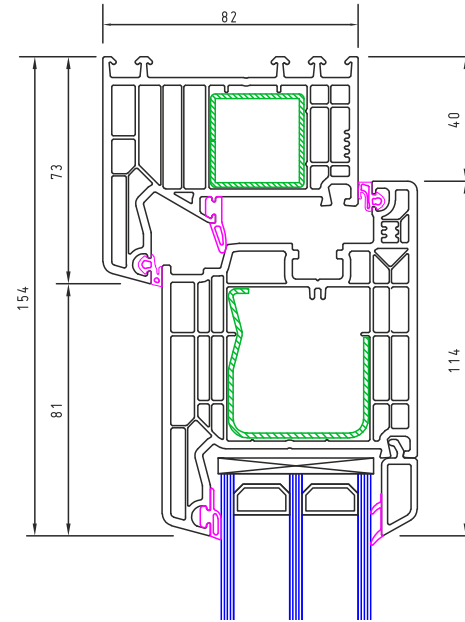
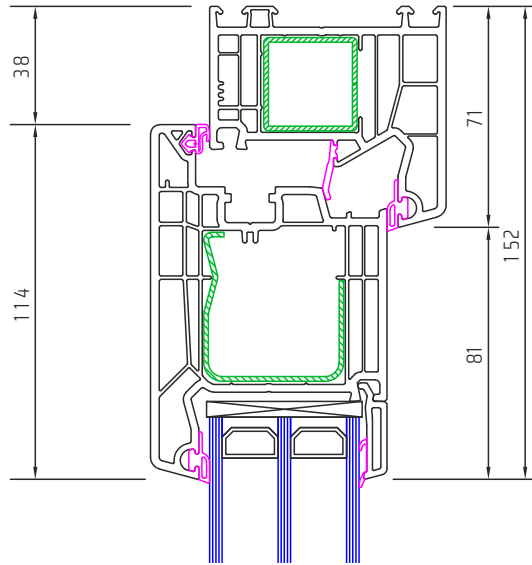
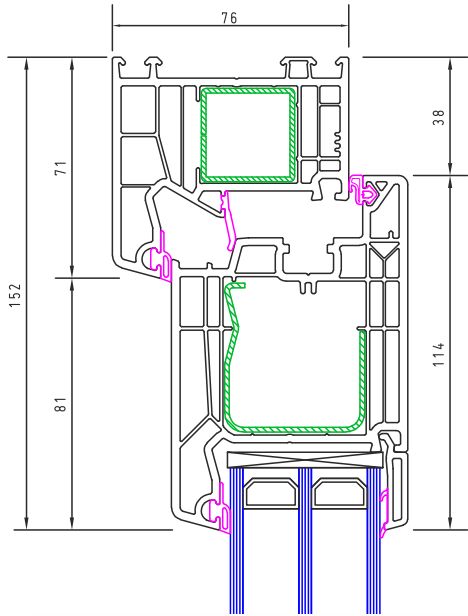

104.530 + 103.385 + 101.350

104.530 + 103.386 + 101.350

104.460 + 103.345 + 101.290

104.460 + 103.346 + 101.290

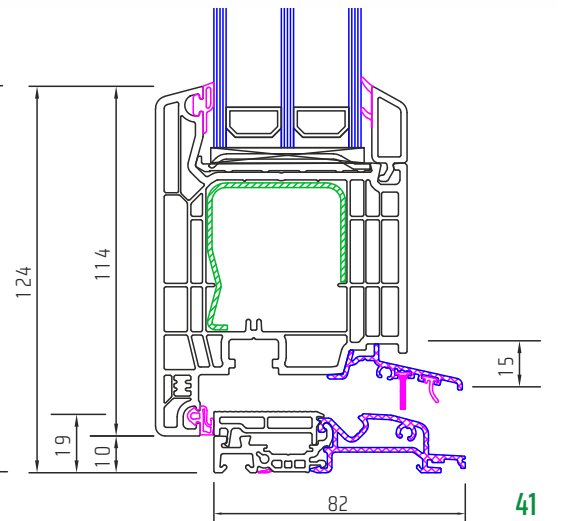
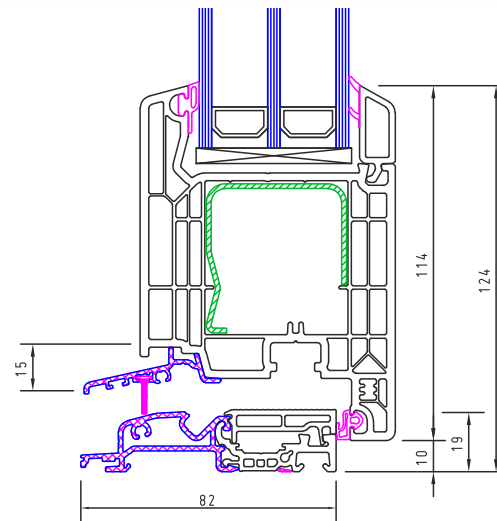
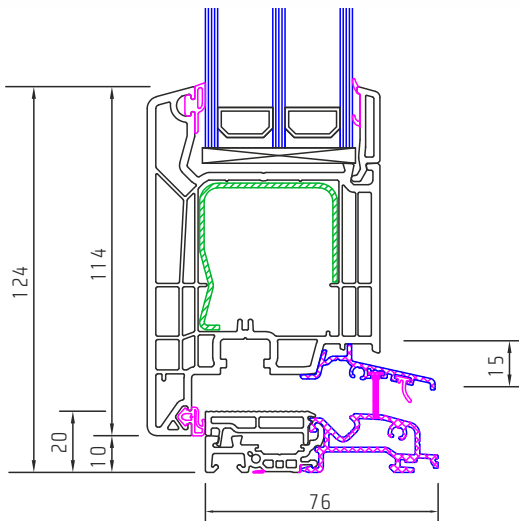
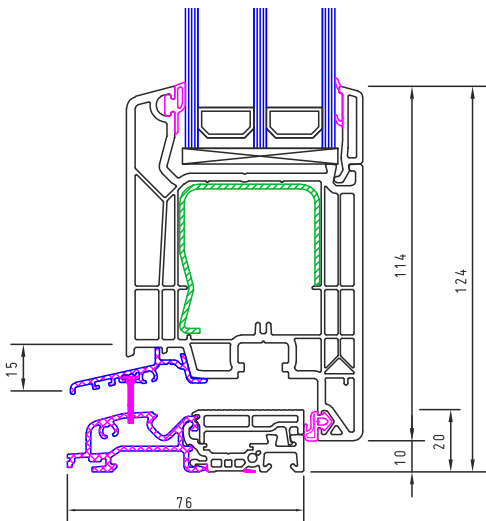

# COULISSANTS - PATIO

Perfectline

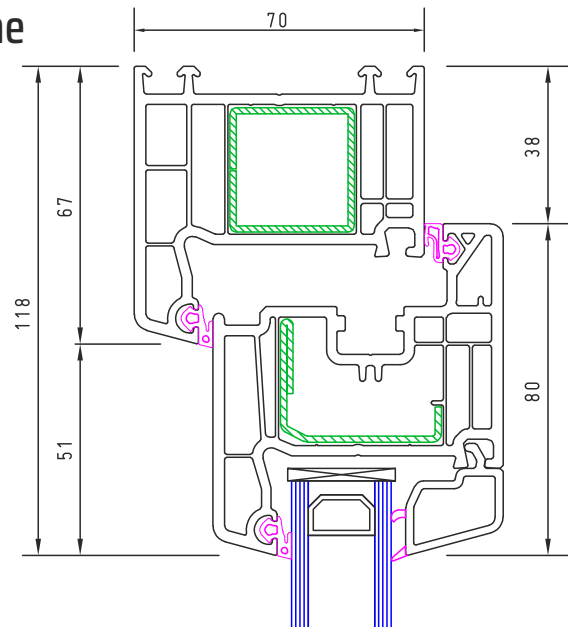

**101.208 + 103.232**

S-line

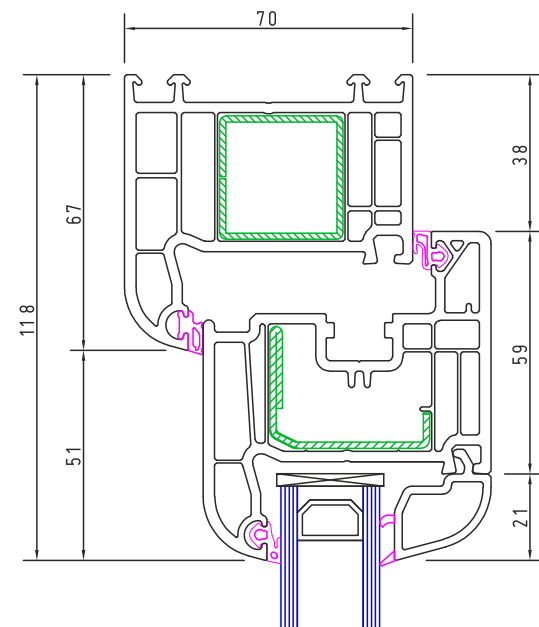

**101.233 + 103.235 PATIO**

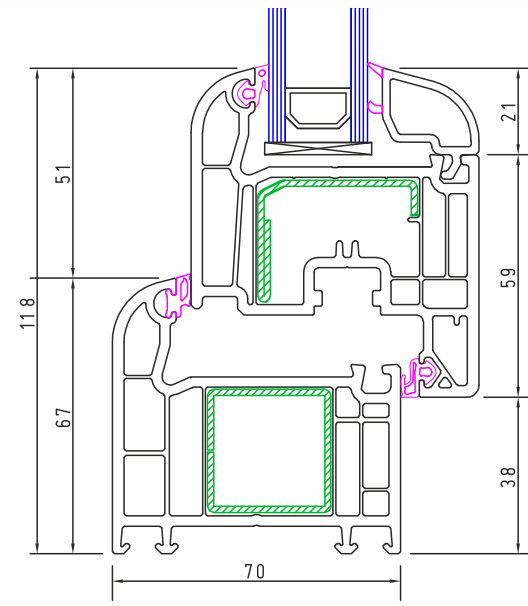
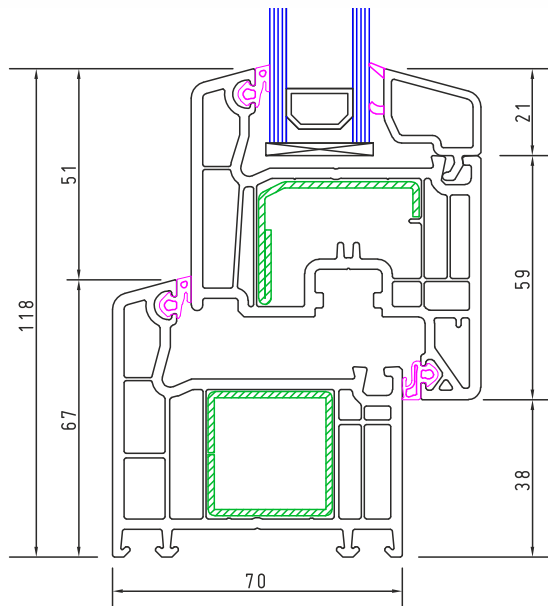

## Swingline

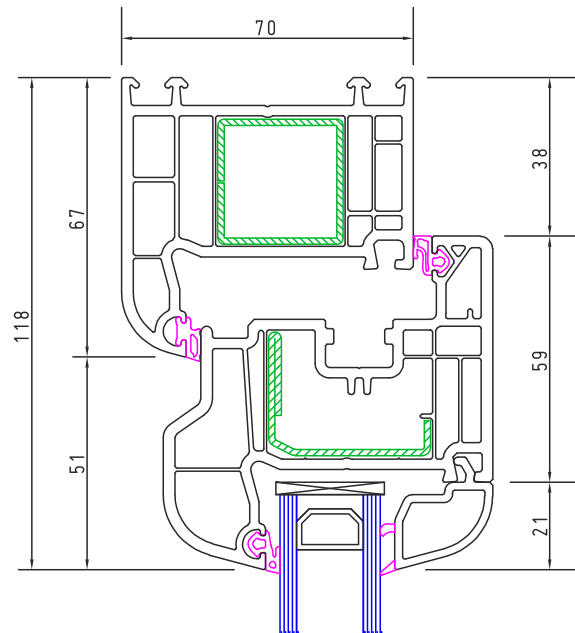

**101.233 + 103.236 PATIO**

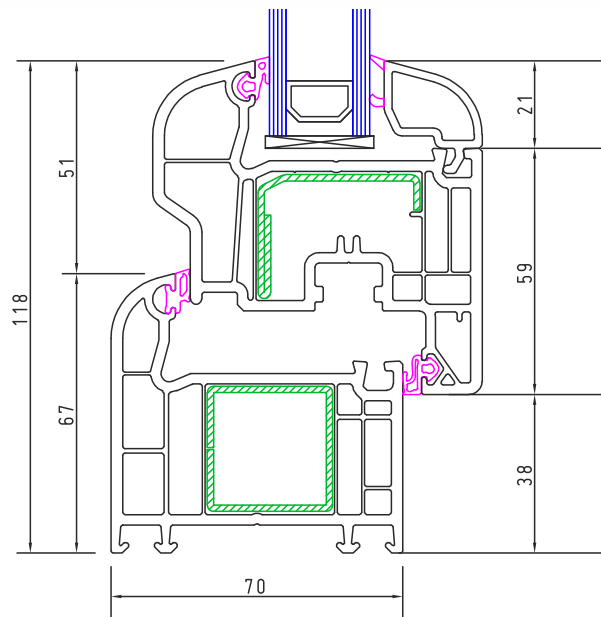

## Softline RENO 35

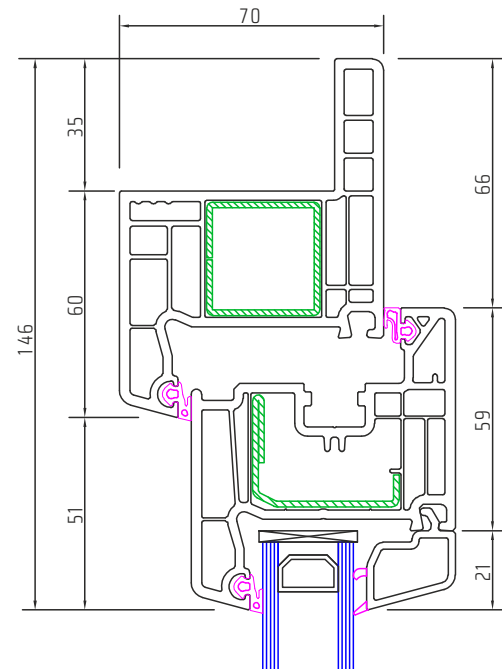

**101.218 + 103.232**

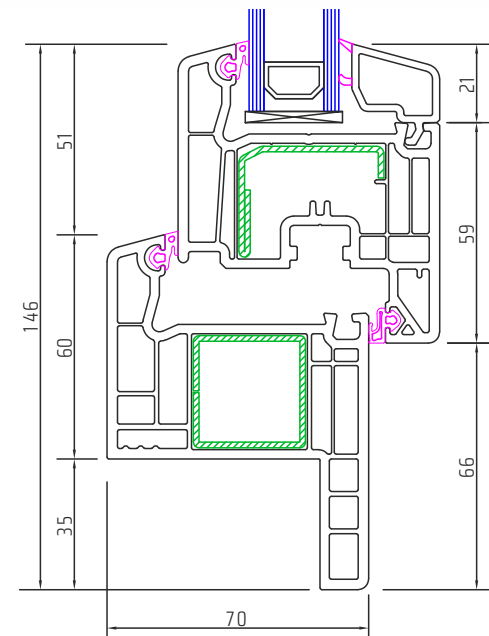

# COULISSANTS - PATIO

Softline 76

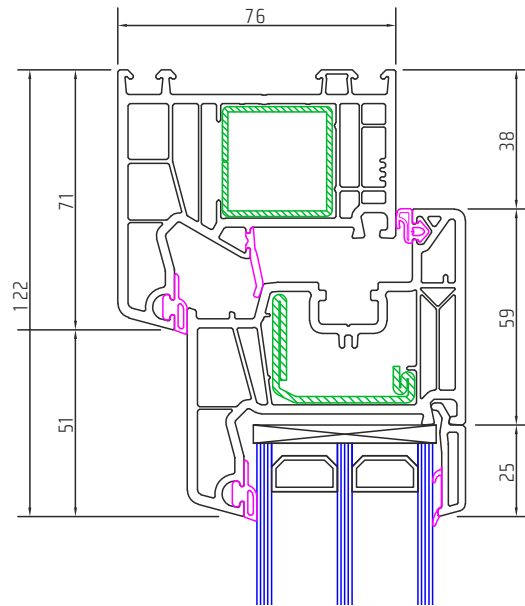

101.350 + 103.381

Softline 82

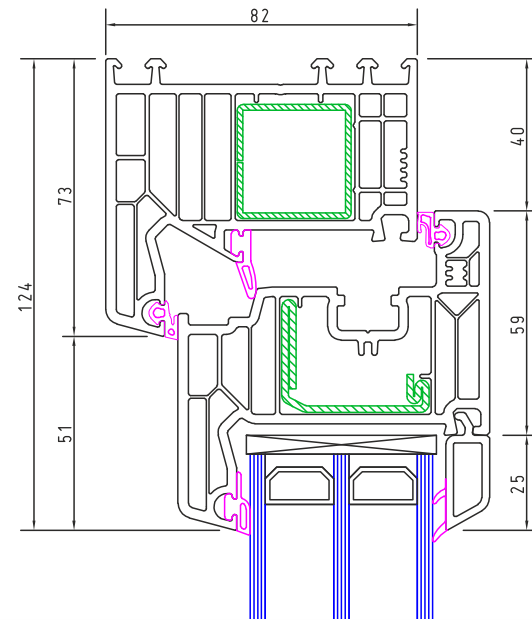

101.290 + 103.341

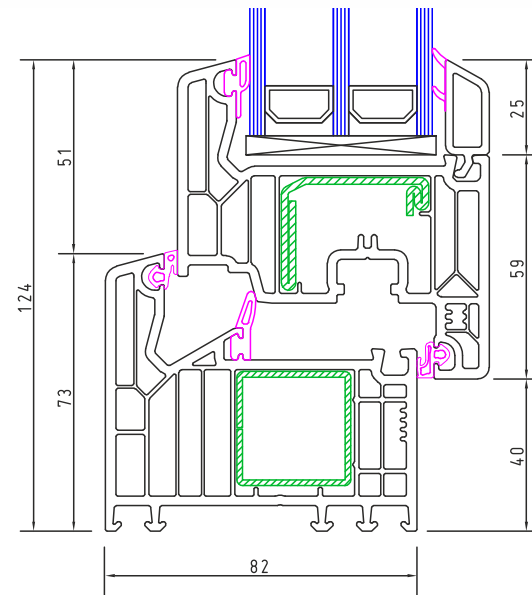
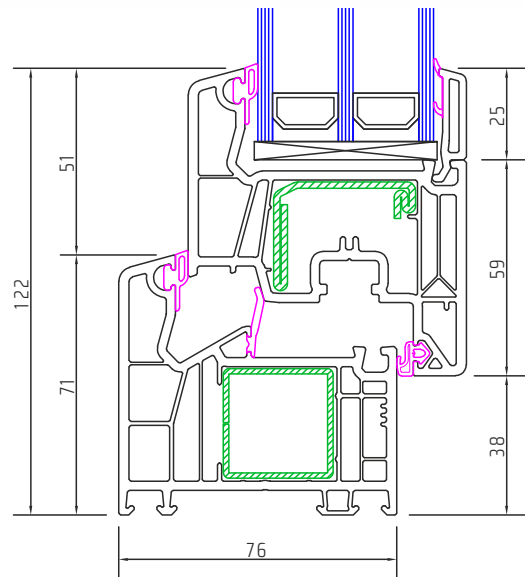

## Fenêtre

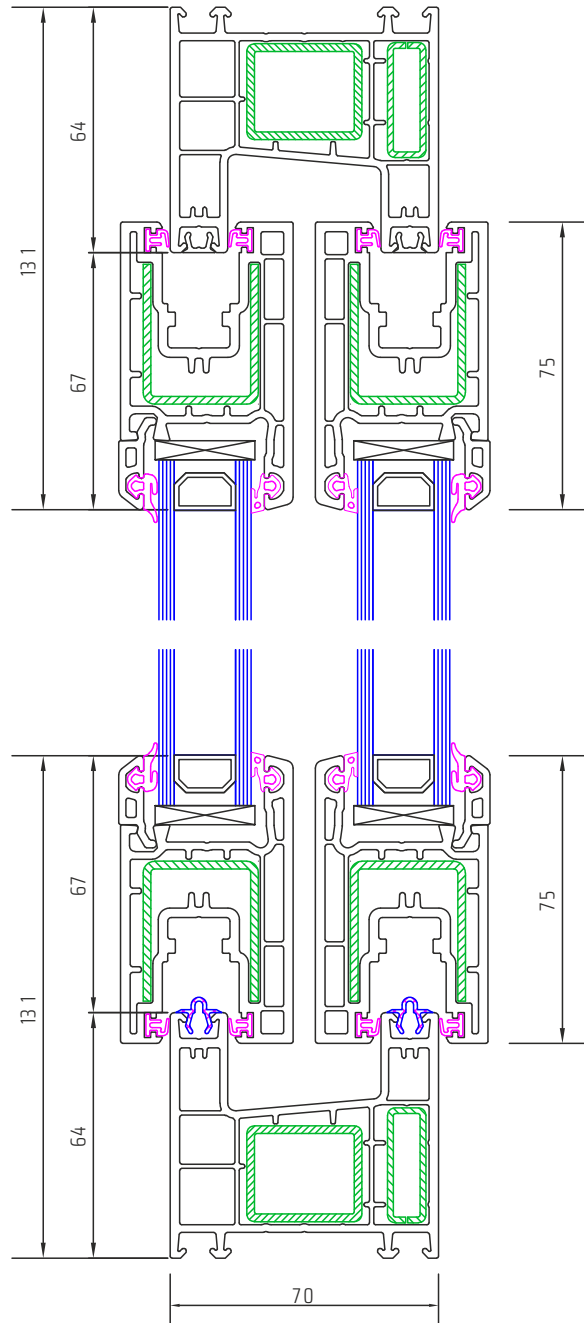

## Porte fenêtre

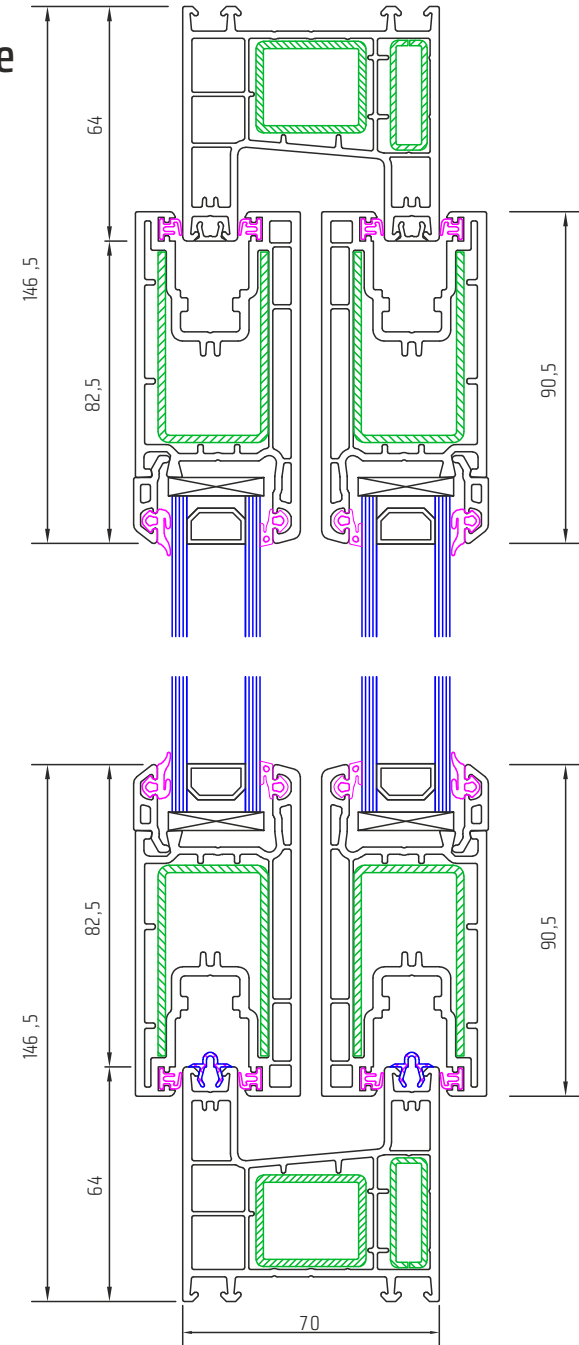

# COULISSANTS A LEVAGE – HST 70

Coupe transversale

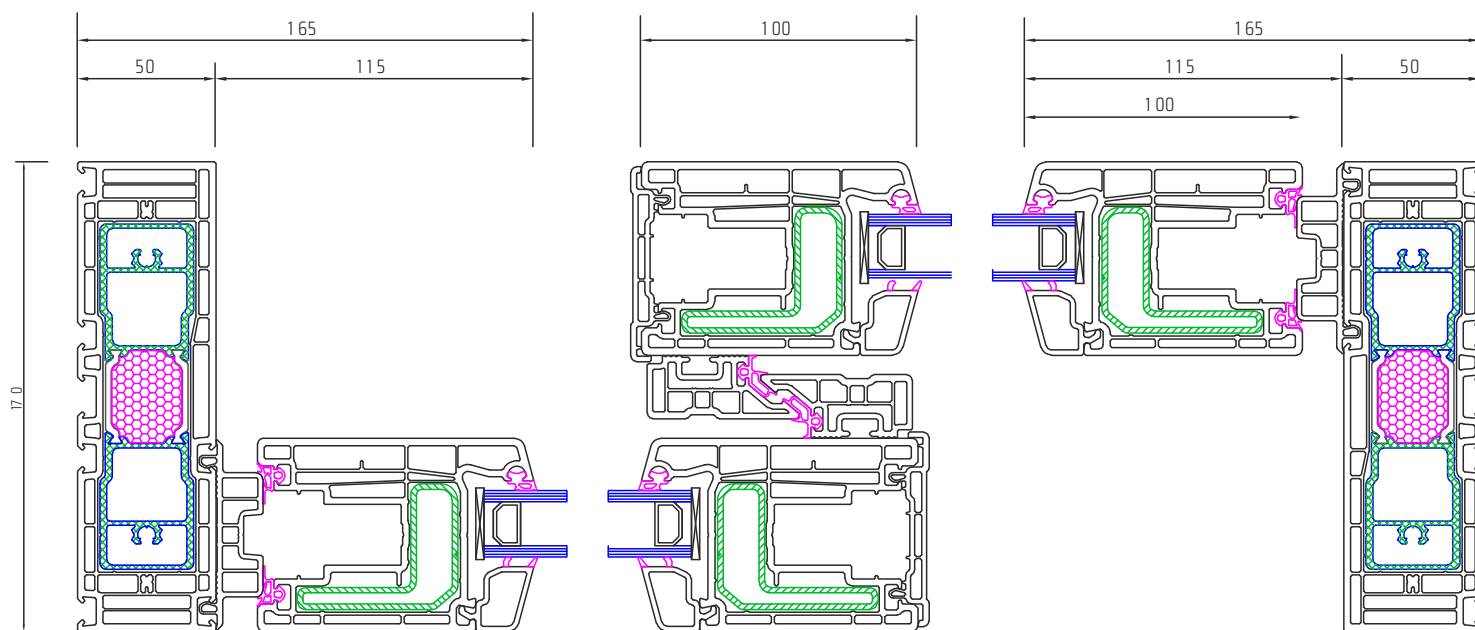

Coupe verticale

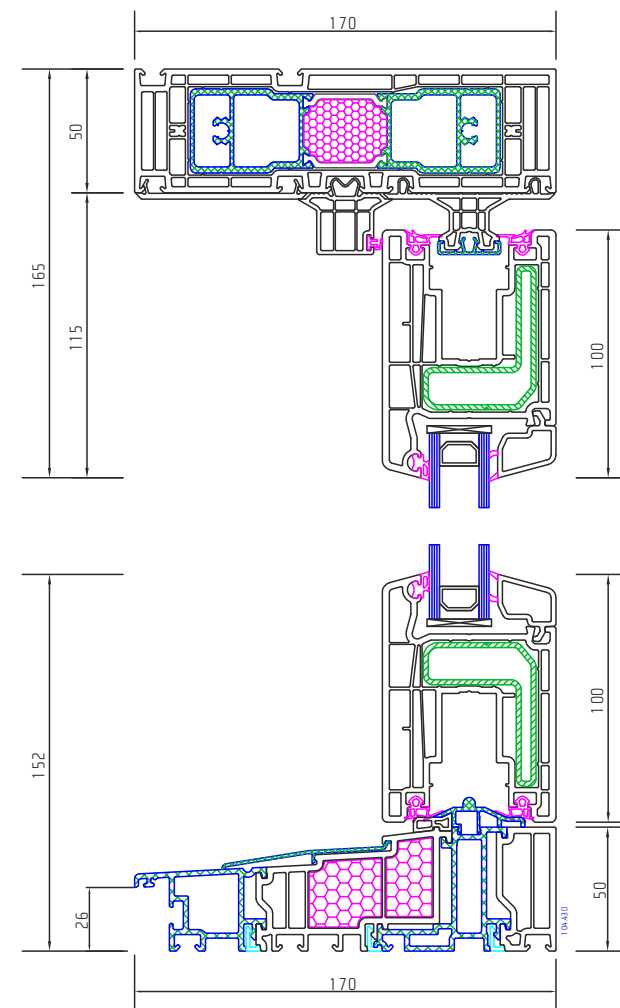



Coupe transversale

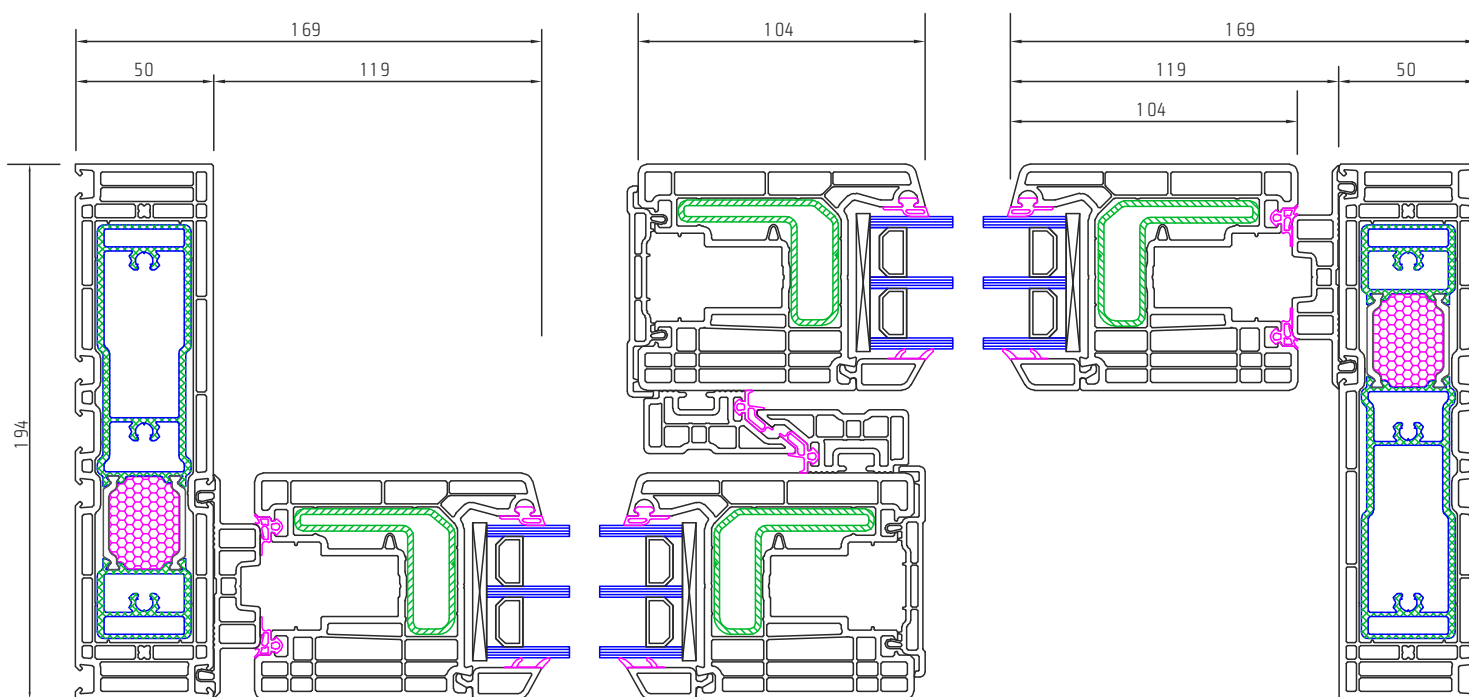

Coupe verticale

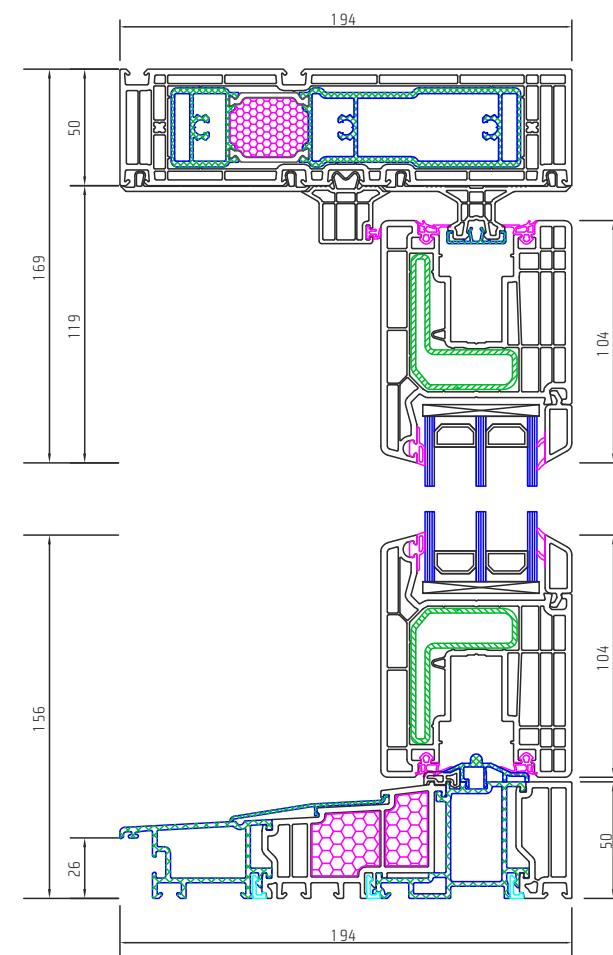

# QUINCAILLERIE

## Plan de quincaillerie ouverture à la française

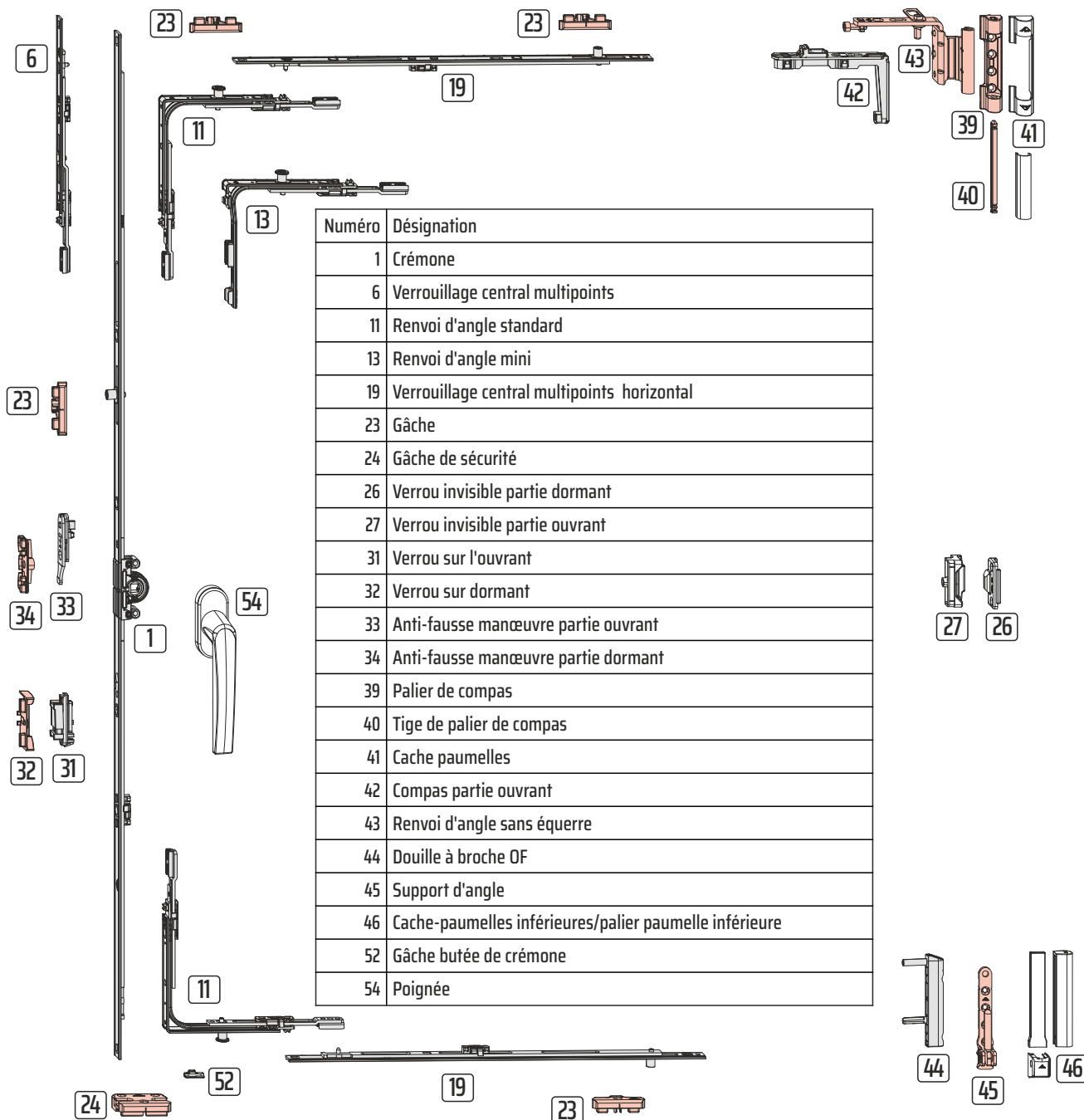
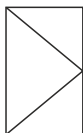

## Plan de quincaillerie ouverture à soufflet

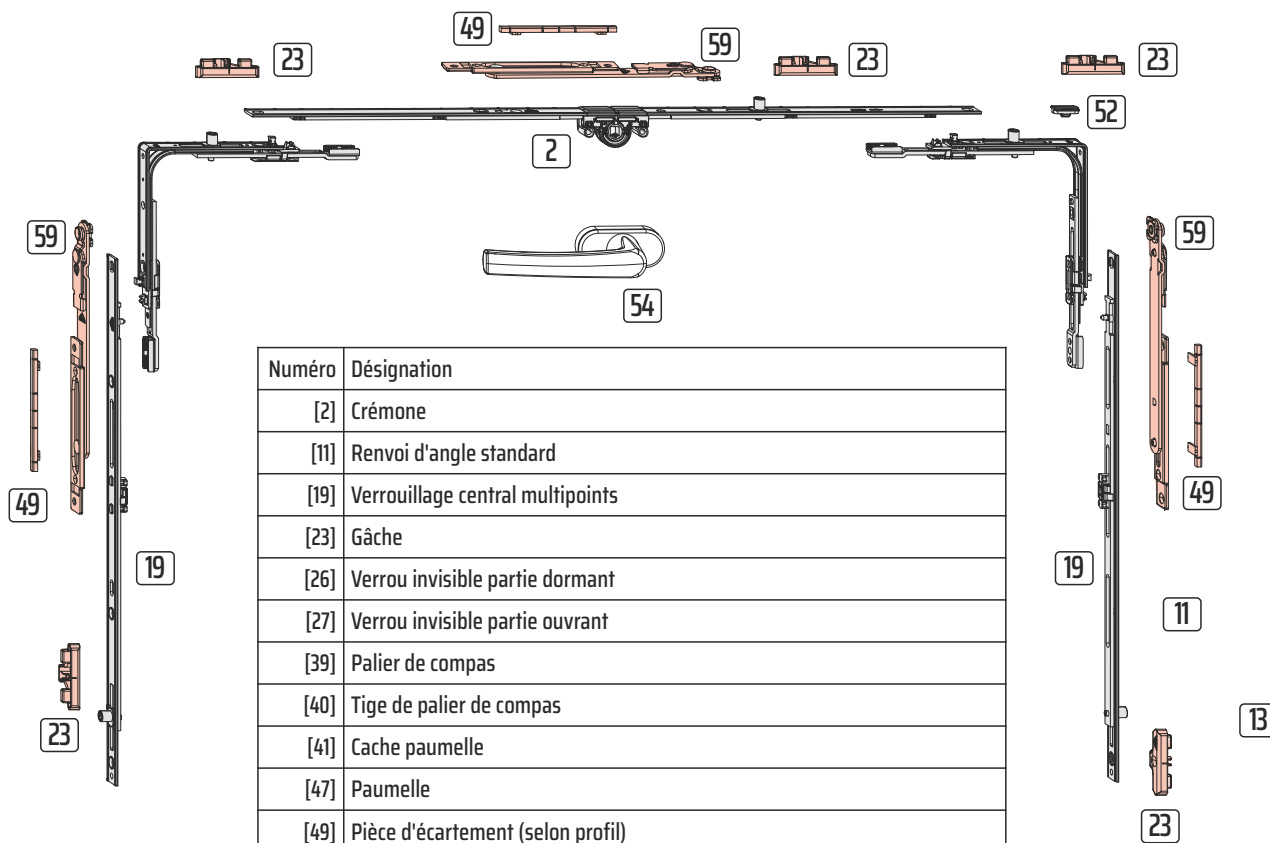

Numéro	Désignation
[2]	Crémone
[11]	Renvoi d'angle standard
[19]	Verrouillage central multipoints
[23]	Gâche
[26]	Verrou invisible partie dormant
[27]	Verrou invisible partie ouvrant
[39]	Palier de compas
[40]	Tige de palier de compas
[41]	Cache paumelle
[47]	Paumelle
[49]	Pièce d'écartement (selon profil)
[52]	Gâche butée de crémone
[54]	Poignée
[59]	Kit de limiteurs d'ouverture

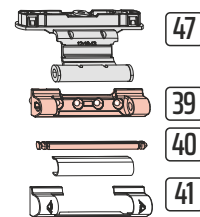
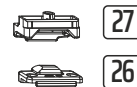
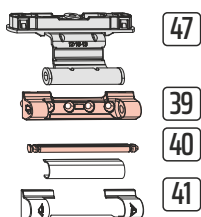

# QUINCAILLERIE

## Plan de quincaillerie ouverture oscillo-battante

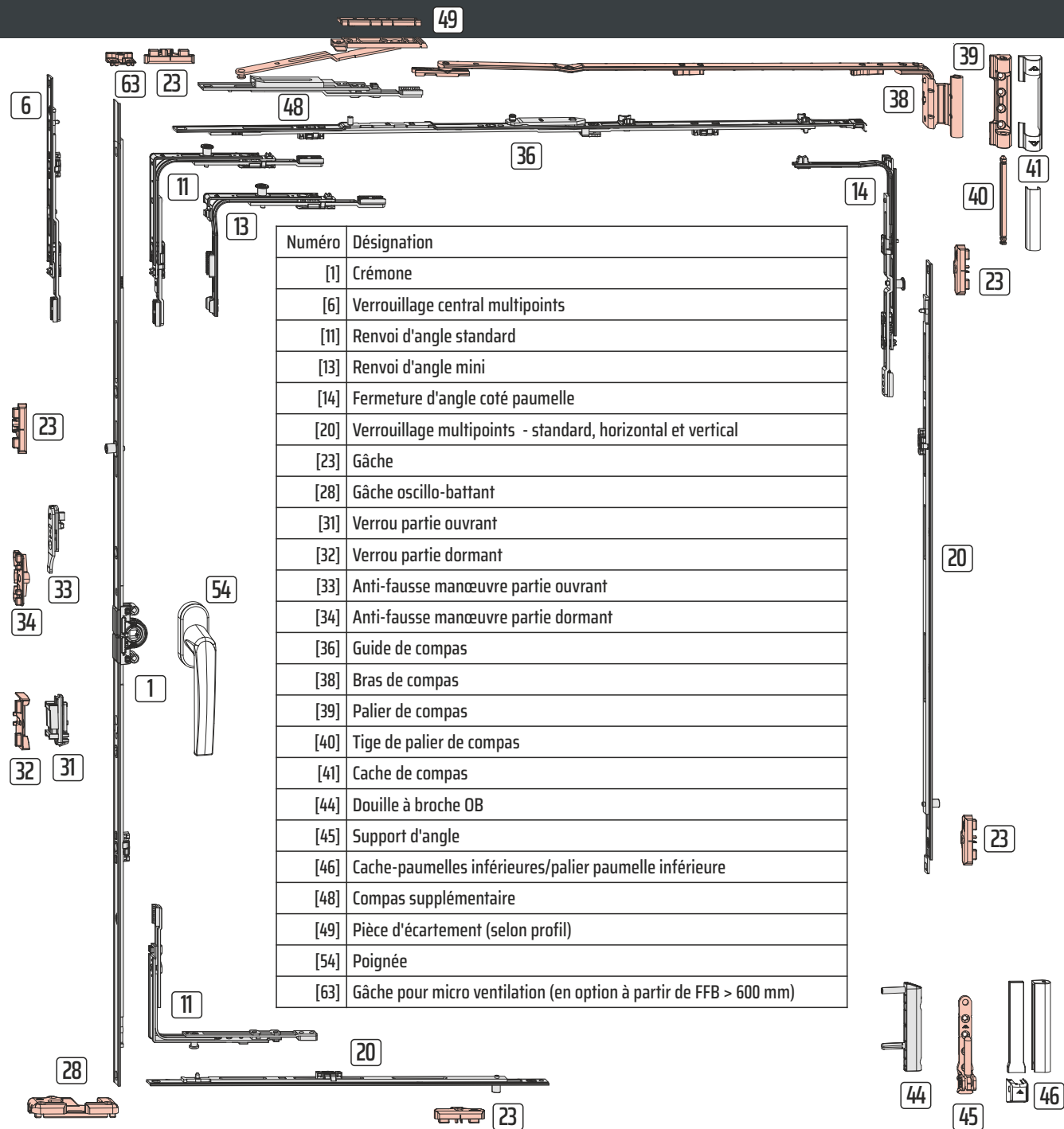

## Plan de quincaillerie ouverture oscillo-battante/ meneau mobile

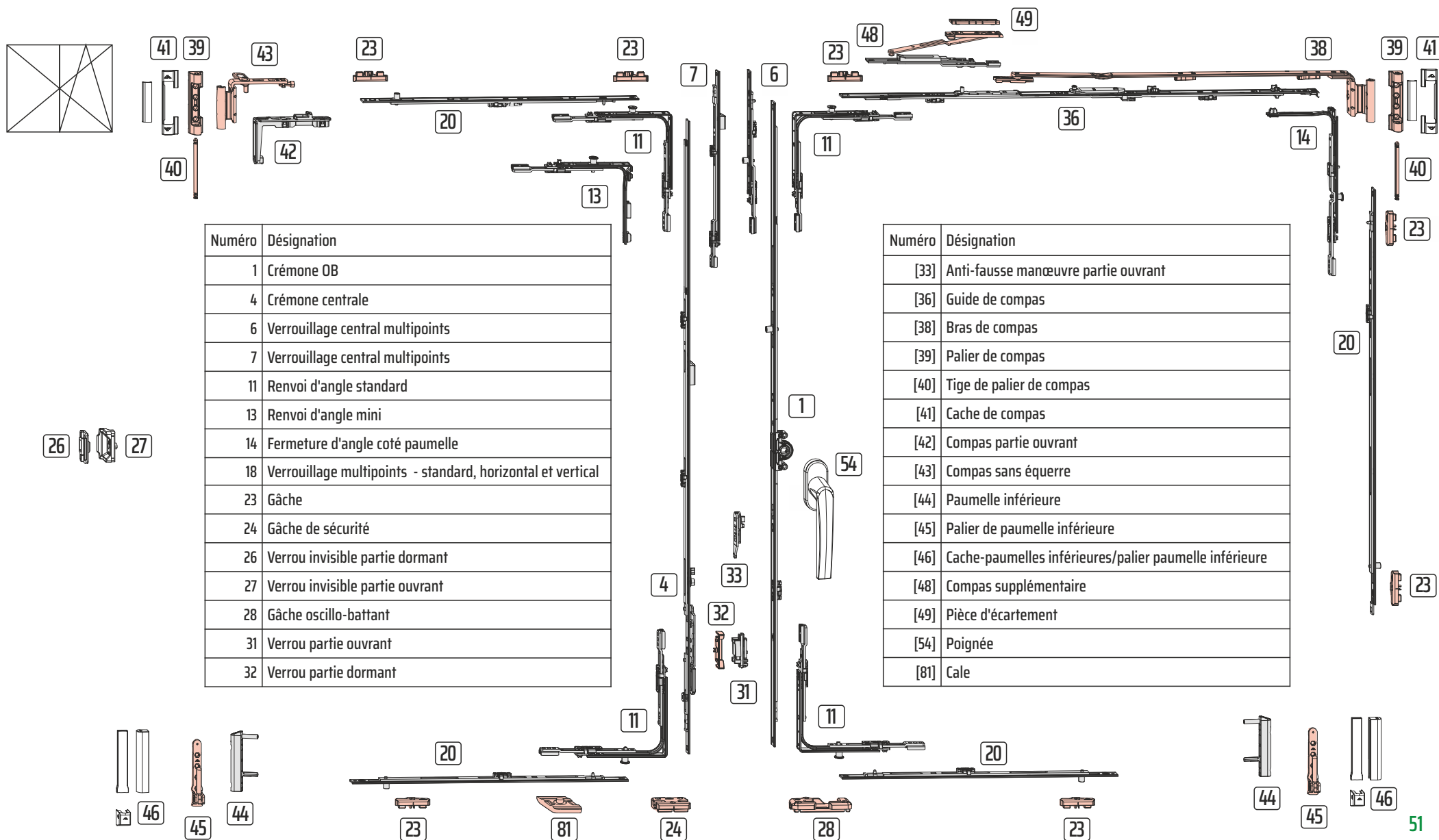

# VOLETS ROULANTS – SKT type bloc-baie OPOTERM

Le bloc-baie ( volet avec caisson ) est directement monté sur le dormant. Adapté pour les constructions neuves et pour certains cas de la rénovation, les caissons de volets roulants de la gamme "coffre bloc-baie" allient esthétique et technologie. Un large choix de manœuvre : manuelle ou électrique. Moustiquaire intégrée en option.



## Coffre

170/230

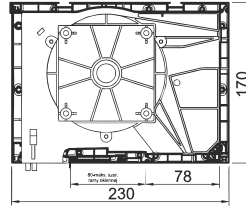

210/230

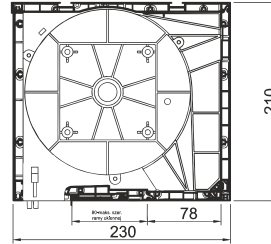

255/240

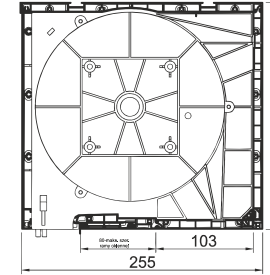

## Coffre arrondi

170/230

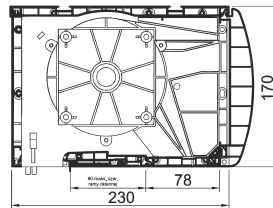

210/230

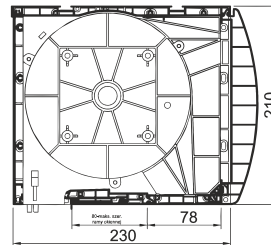

255/240

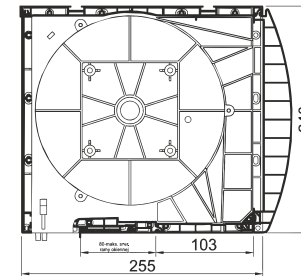

## Coulisses

Coulisse standard  
PPD 60/12

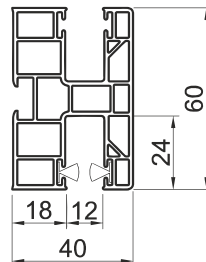

Coulisse moustiquaire  
PPDM 60/12

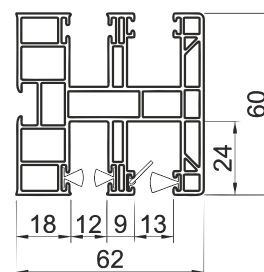

Coulisse en alu  
PPDA 60/12

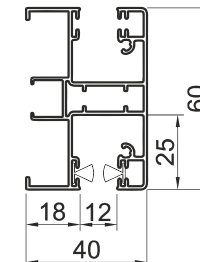

# VOLETS ROULANTS – type bloc-baie BeClever

Le bloc-baie ( volet avec caisson ) est directement monté sur le dormant. Adapté pour les constructions neuves et pour certains cas de la rénovation, les caissons de volets roulants de la gamme "coffre bloc-baie" allient esthétique et technologie. Un large choix de manœuvre : manuelle ou électrique. Moustiquaire intégrée en option.

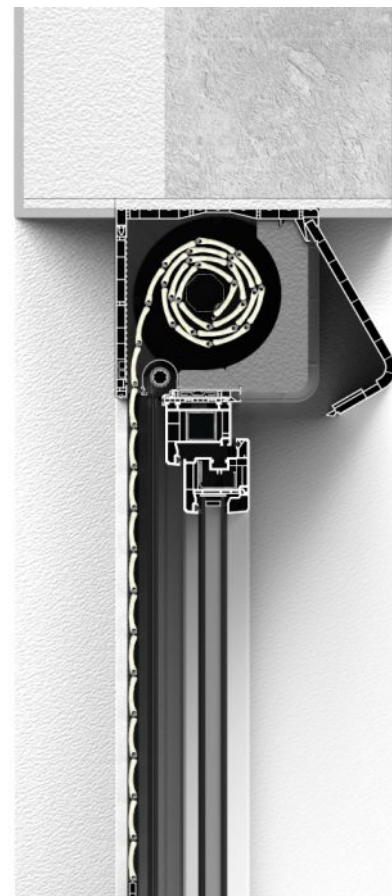
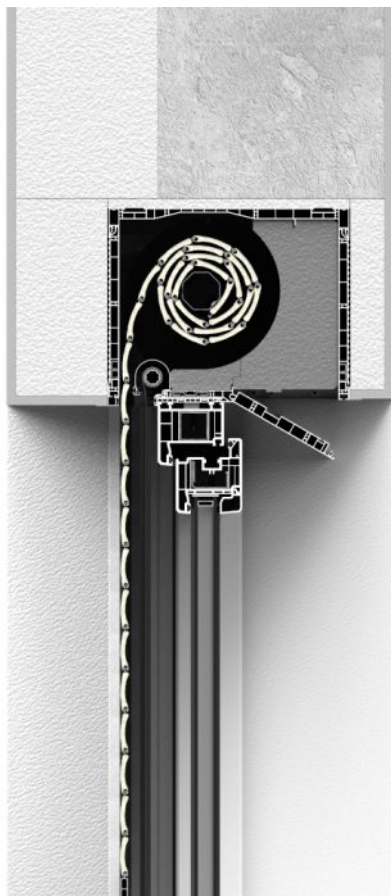



## Coffres CLEVERBOX

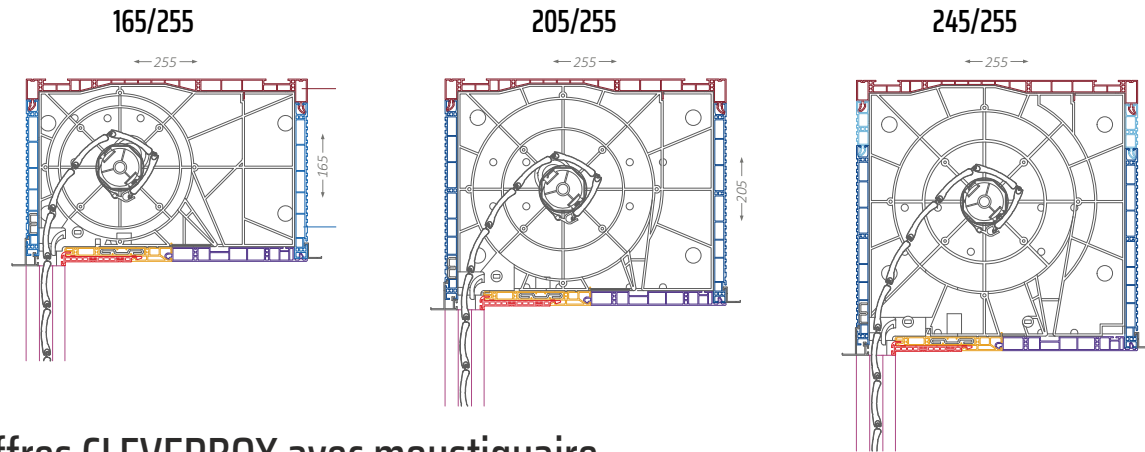

## Coffres arrondis CLEVERBOX

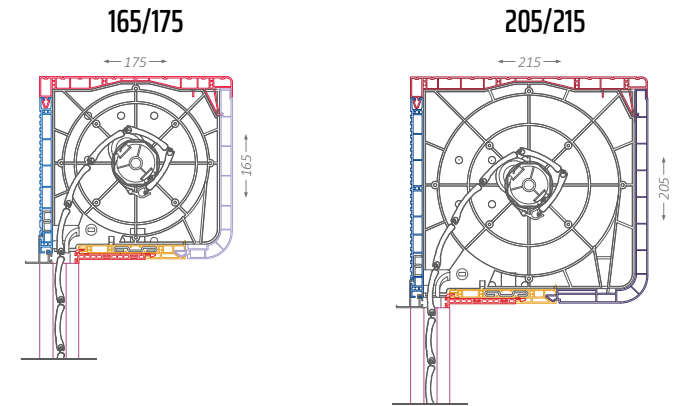

## Coffres CLEVERBOX avec moustiquaire

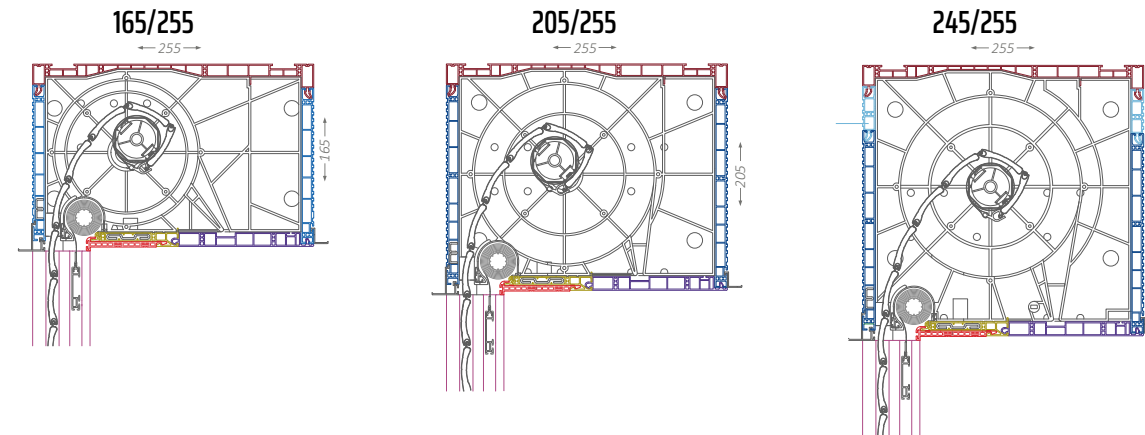

## Coffres arrondis CLEVERBOX avec moustiquaire

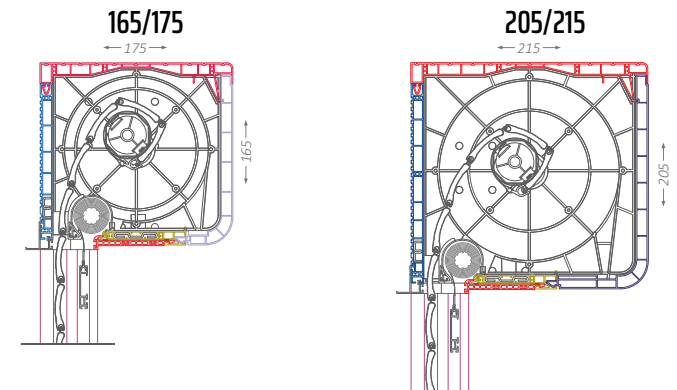

## Coulisses BeClever

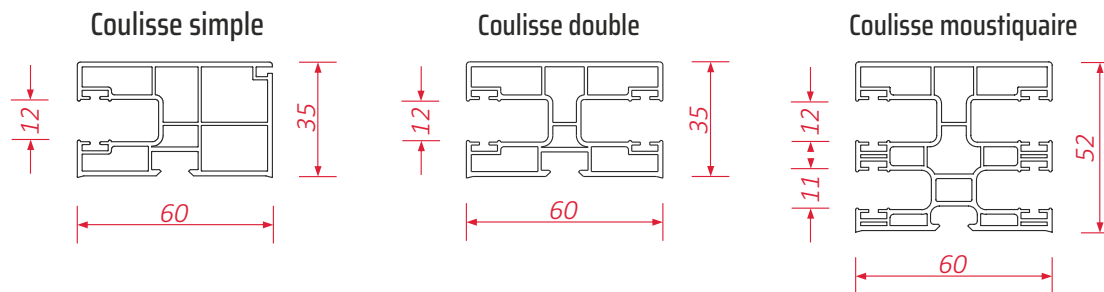

# VOLETS ROULANTS type rénovation SK, SKP

Le volet roulant rénovation est réalisé sur mesure pour équiper des fenêtres existantes qui n'en ont pas été dotées à l'origine.

D'une pose aisée, sans dégradation, et d'un confort maximum, ce volet s'adapte à tout type de façade ou de construction.

SK - coffre à pan coupé. SKP coffre à pan arrondi.

Un large choix de manœuvre: manuelle ou électrique. Moustiquaire intégrée en option.

SK

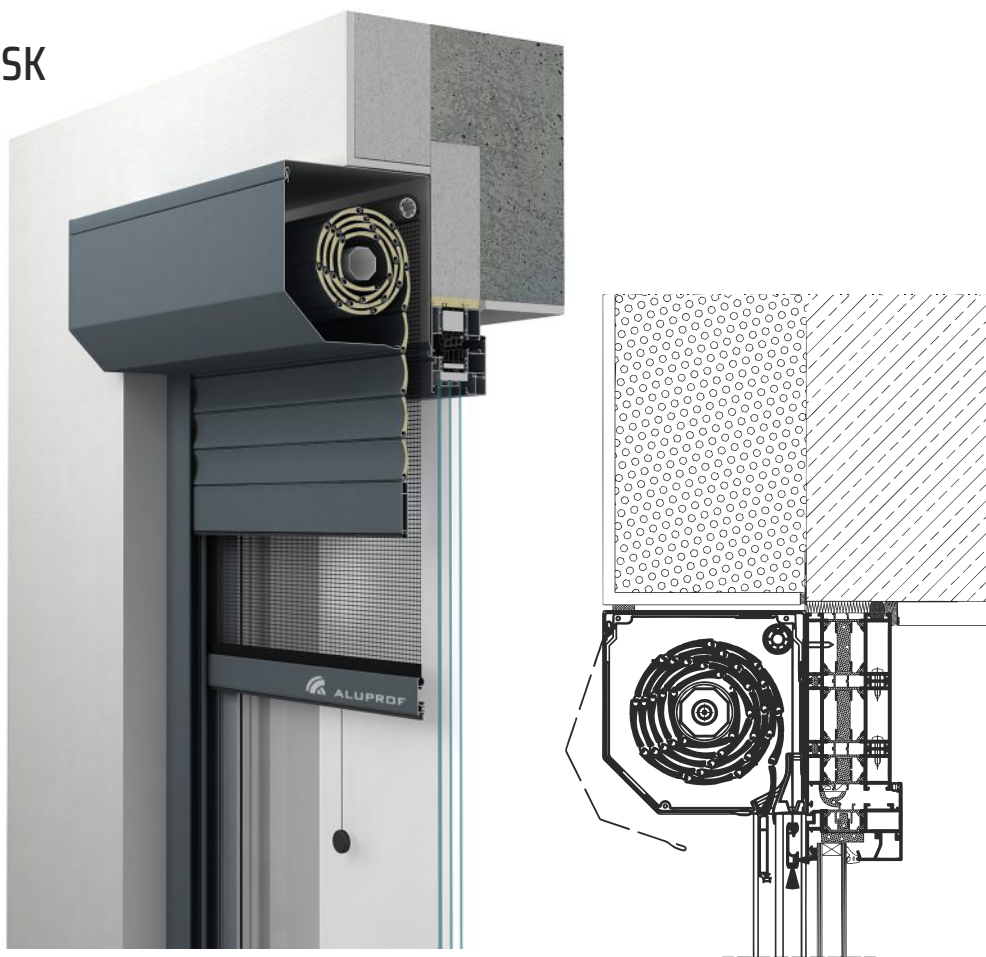

SKP

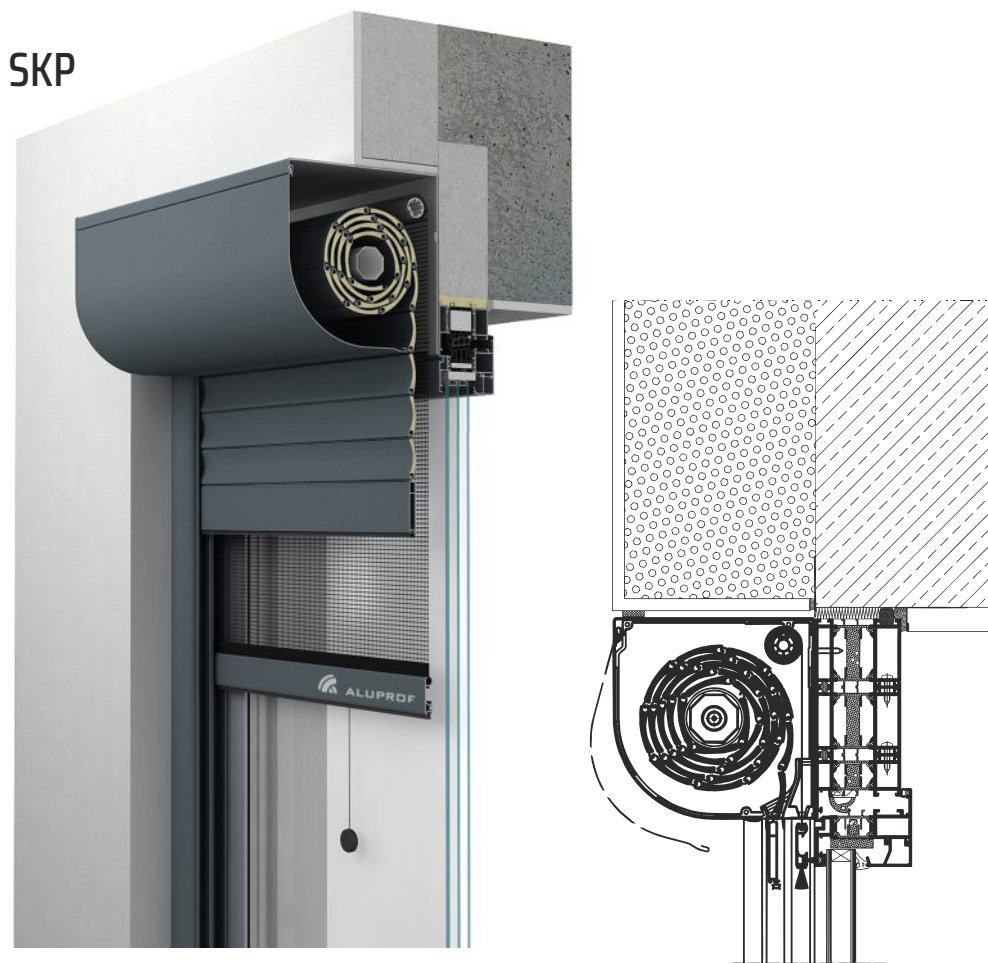

### Coffres SK

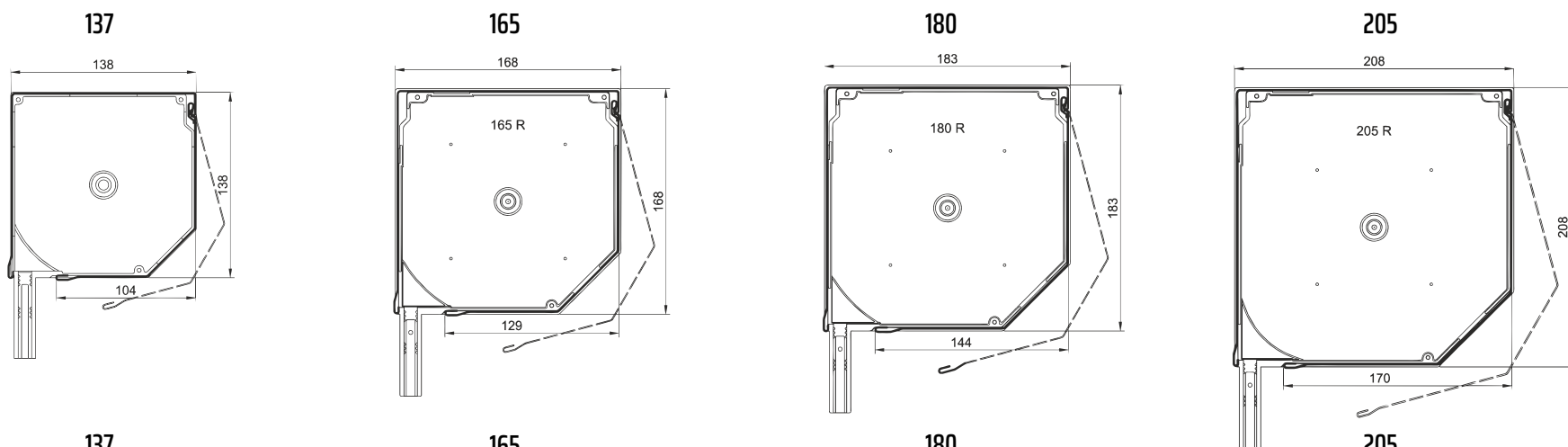

### Coffres SKP

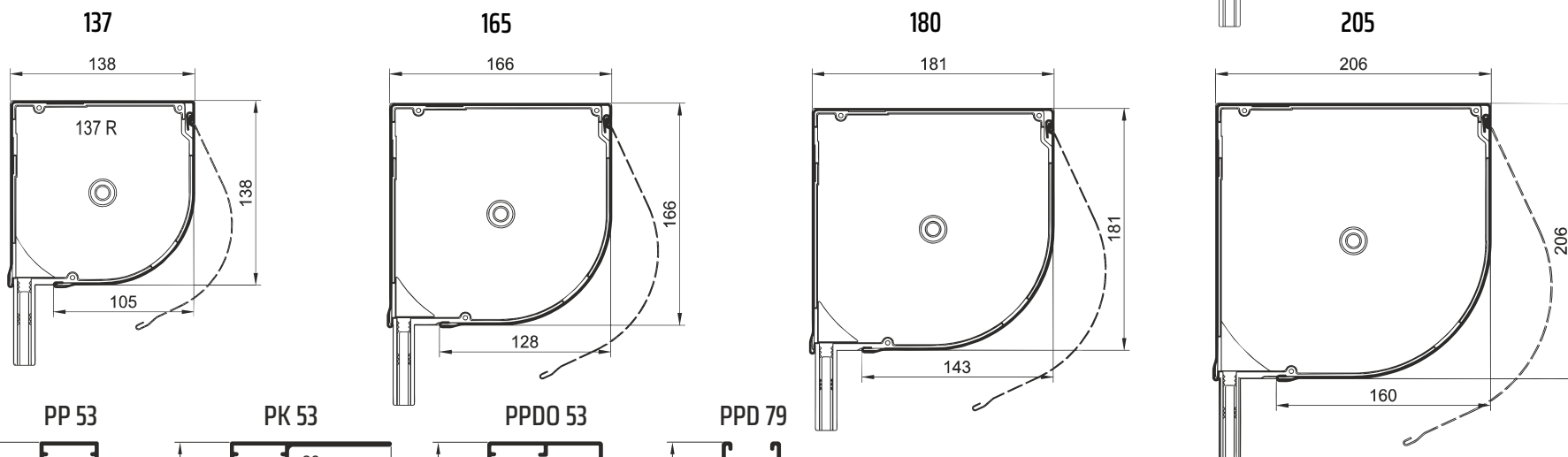

### Coulisses

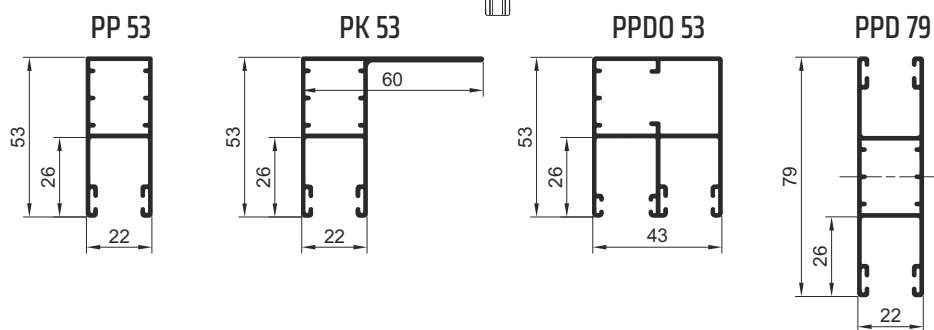

# VOLETS ROULANTS type rénovation SKO-P

Le volet roulant rénovation est réalisé sur mesure pour équiper des fenêtres existantes qui n'en ont pas été dotées à l'origine.

D'une pose aisée, sans dégradation, et d'un confort maximum, ce volet s'adapte à tout type de façade ou de construction.

Le coffre SKO-P est conçu d'une tôle en aluminium laquée dans le système PU/PA – un revêtement hautement résistant aux produits chimiques et aux intempéries

Un large choix de manœuvre : manuelle ou électrique.

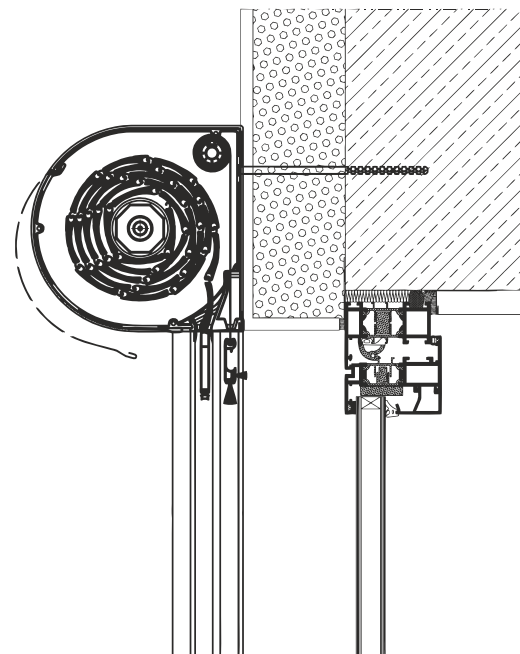

## Coffres

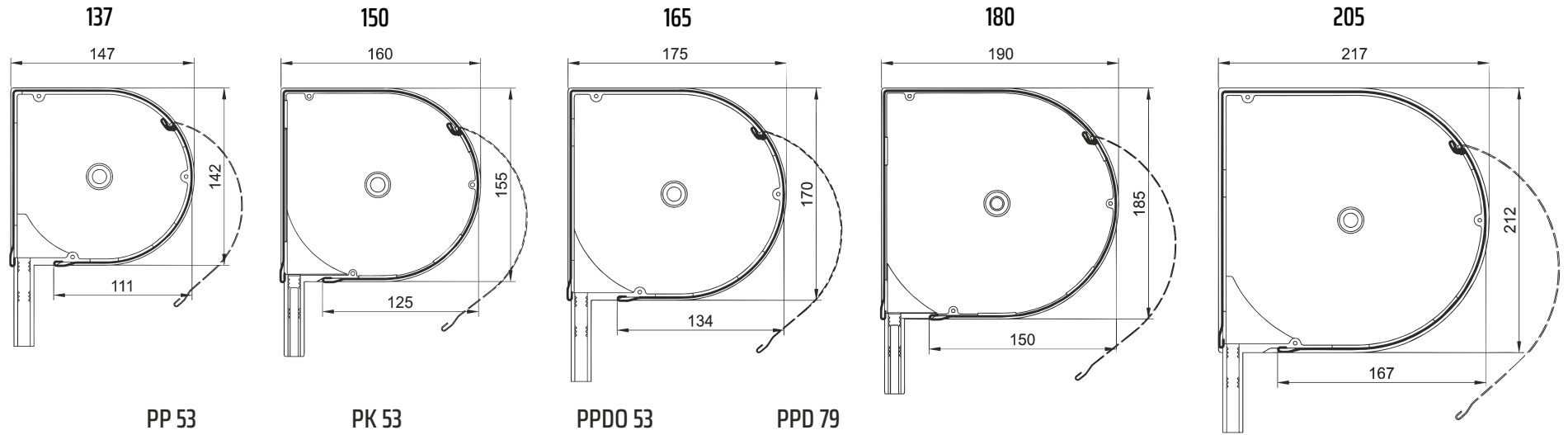

## Coulisses

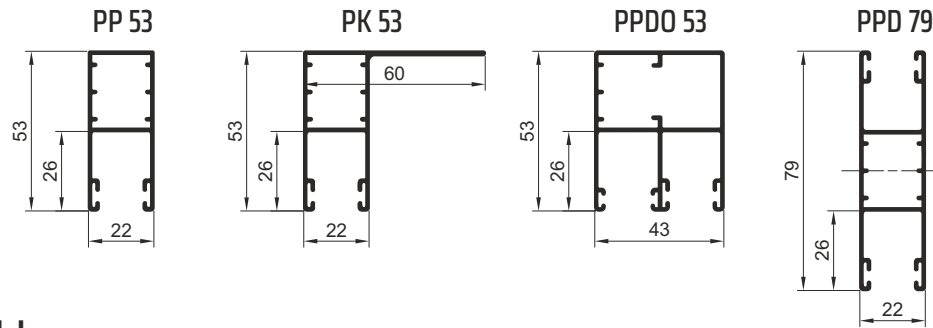

## Lames disponibles

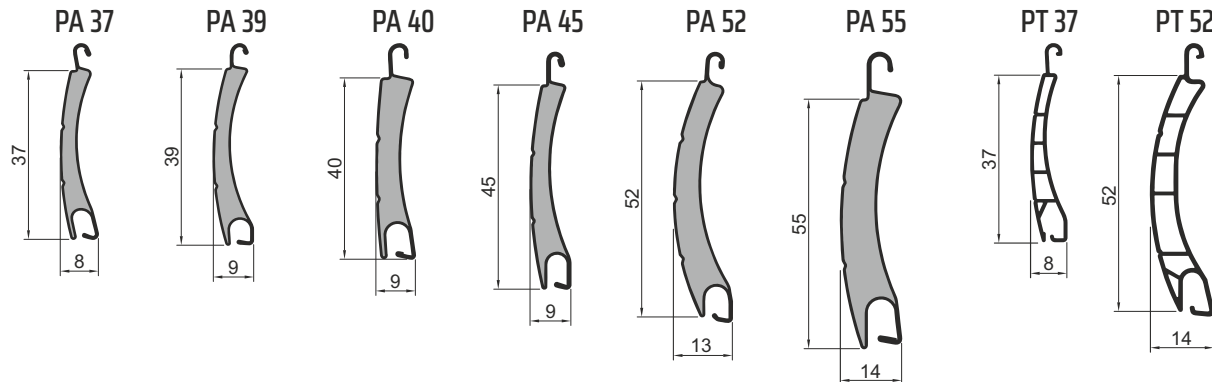

Lame à double paroi injectée de mousse polyuréthane isolante

Lame sans remplissage

Lame ajourée

Lame non-ajourée



# VOLETS TYPE SOUS-ENDUIT SP-E

Coffre à poser sous-enduit, ce type de volet est adapté pour la construction neuve.

Un large choix de manœuvre: manuelle ou électrique.

Moustiquaire intégrée en option.

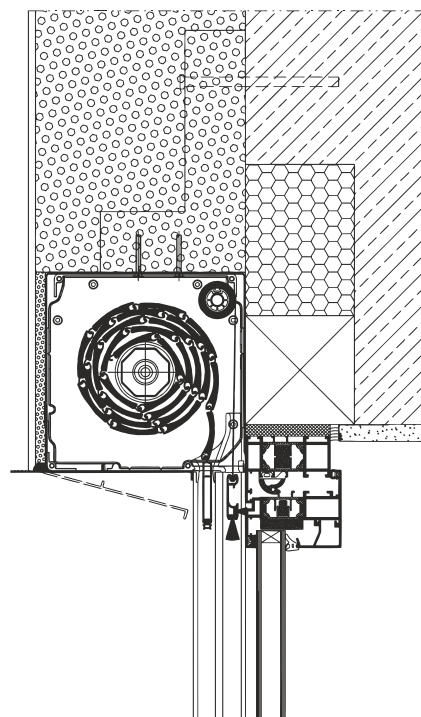

## Coffres

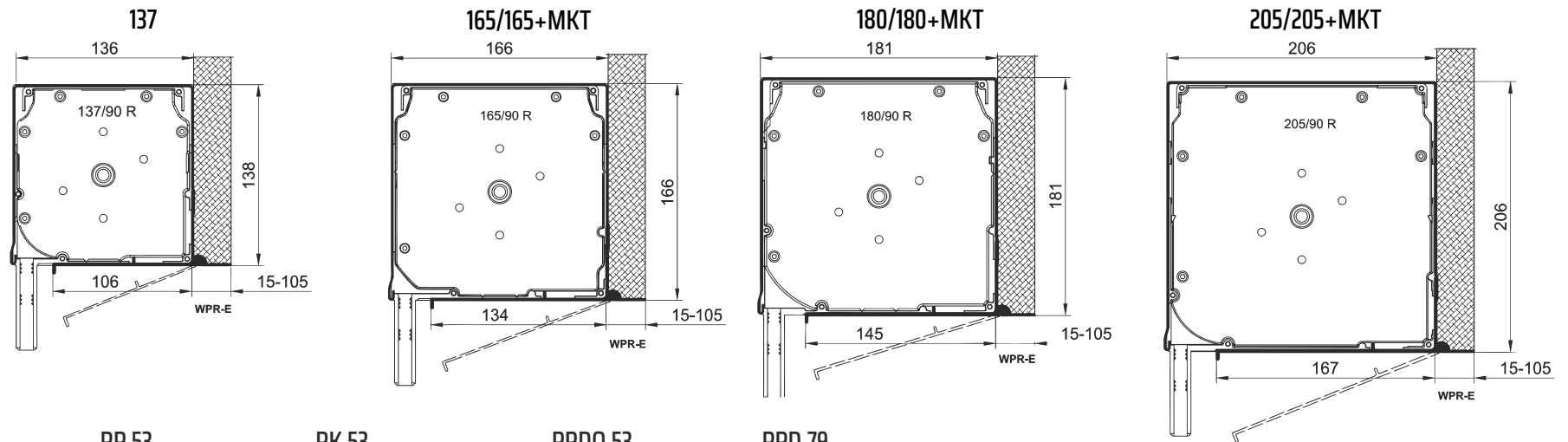

## Coulisses

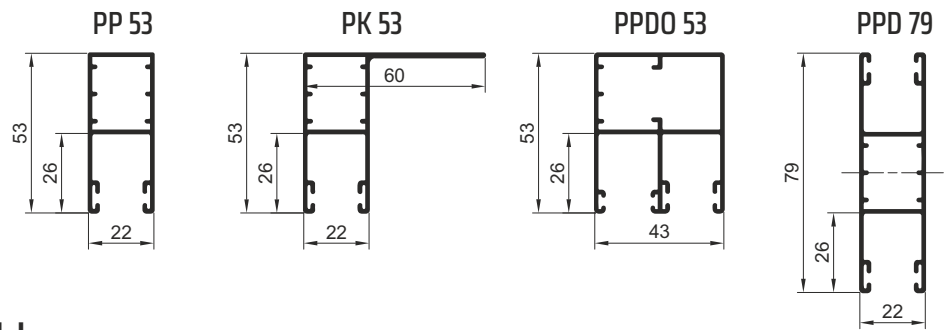

## Lames disponibles

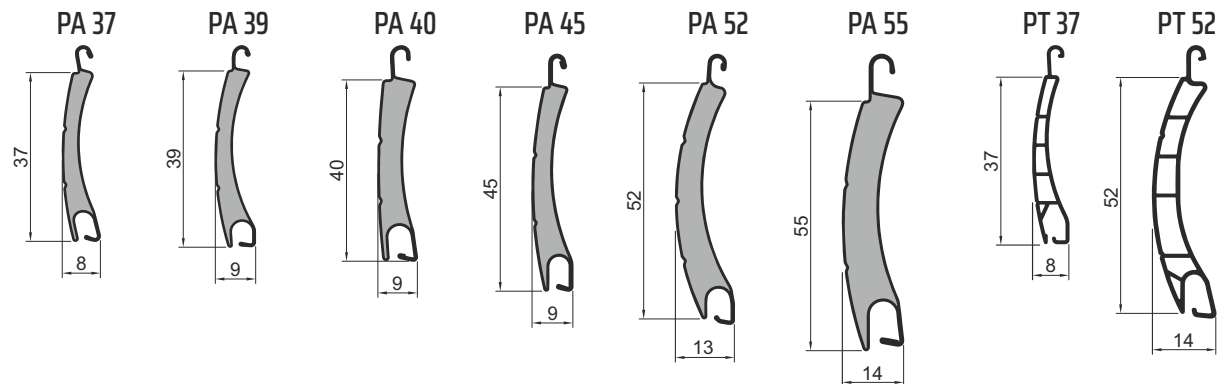

Lame à double paroi injectée de mousse polyuréthane isolante

Lame sans remplissage

Lame ajourée

Lame non-ajourée



# VOLETS ROULANTS – manœuvre manuelle et filaire

## Accessoires manœuvre manuelle

Enrouleur à sangle



Enrouleur à manivelle



Manivelle longue + cardan



Enrouleur encastrable



Serrure lame



## Moteur tubulaire

Aluprof



Somfy



Simu



## Interrupteur encastrable

DC318  
(commande 1 volet)



DC282  
(commande 1 volet)



## Émetteur mural

DC229  
(1 canal)



DC315  
(1 canal)



DC448  
horloge de programmation  
(5 canaux)



DC661  
horloge de programmation  
(5 canaux)



DC1770  
(1 canal)



DC1771  
(2 canaux)



Smooove RTS  
(1 canal)





## Moteur tubulaire



## Télécommandes (Aluprof)

### 1 canal



### mini

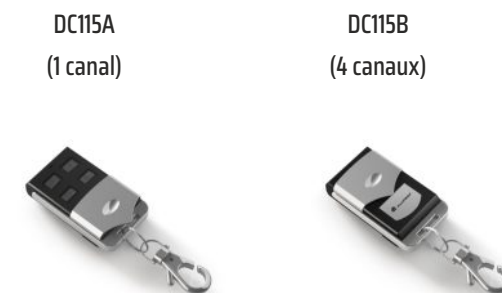

### 5 canaux



## Télécommandes (Somfy/Simu)

### 15 canaux



### Pure Situo



### Telis 16



# VOLETS ROULANTS – manœuvre IO SMART HOME SOMFY

## Émetteurs muraux

Smoove RS100 io



Smoove Origin io



Smoove Shine io



## Télécommandes

Situo io



Nina io



## Box domotique

Connexoon



TaHoma Premium



Fabricant de menuiserie PVC, ALU et VR

ABM Fenêtre  
3h rue Pilsudskiego  
95-200 Pabianice  
Pologne

tel: +48 42 225 52 32  
[info@abm-fenetre.fr](mailto:info@abm-fenetre.fr)



09/2021

[www.abm-fenetre.fr](http://www.abm-fenetre.fr)